

NP/GK series

ONOSOKKI

# Excitation • Vibration • Analog Signal Processing System

Wide selection for your solution



# Excitation • Vibration Measurement System

## NP-3000/7000 Series (Built-in preamplifier type)

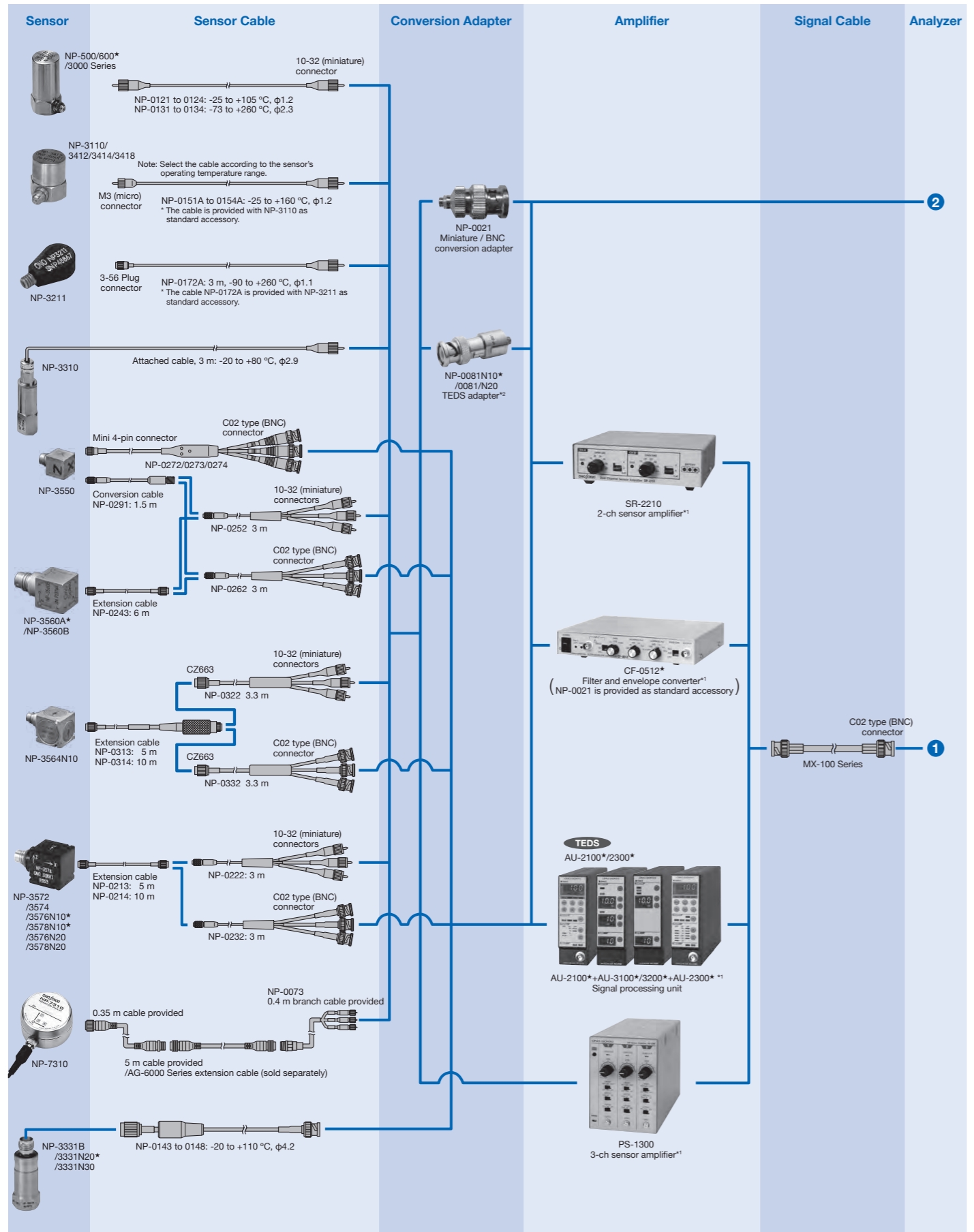

Models with ★ have been already discontinued.

## NP-2000 Series (Charge output type)

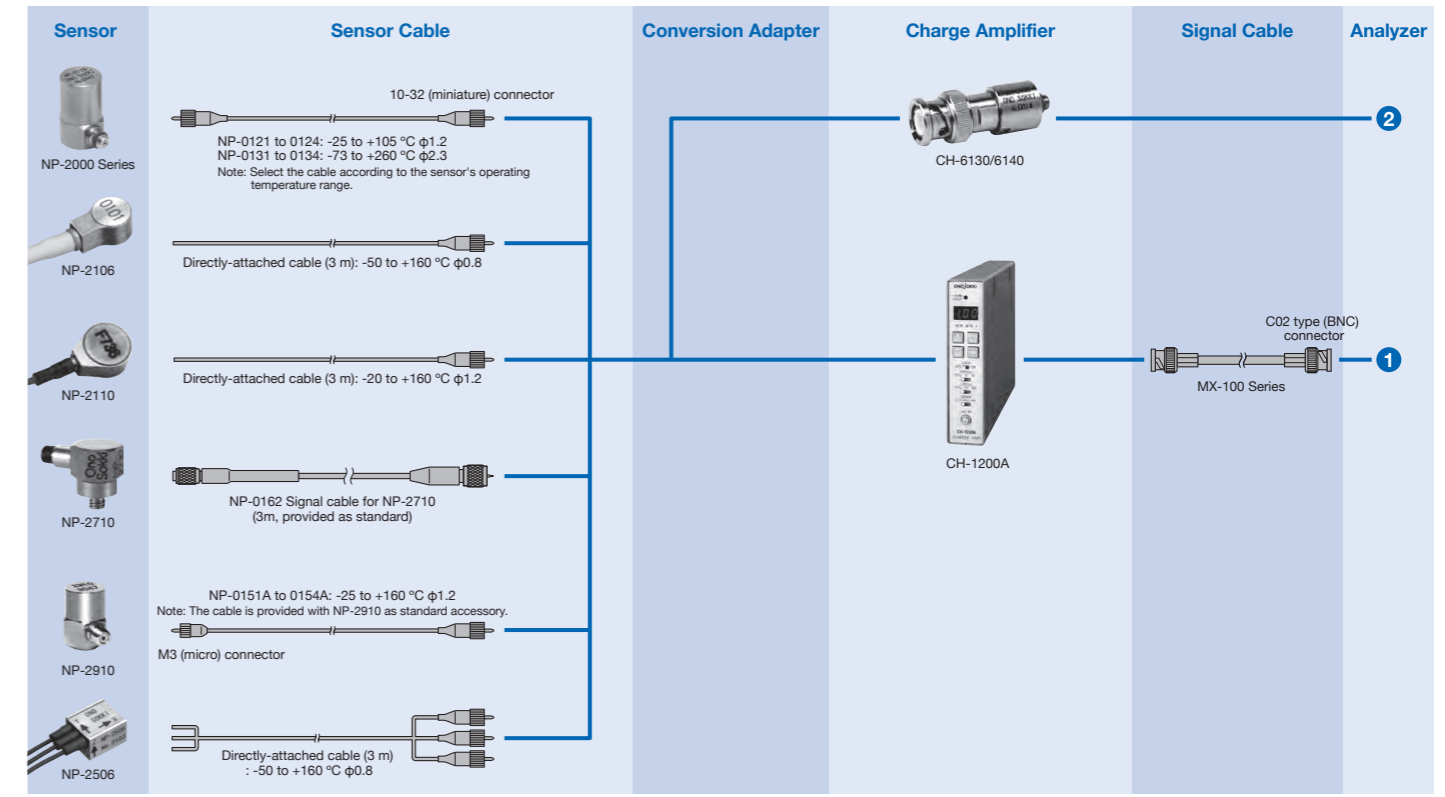

## GK Series

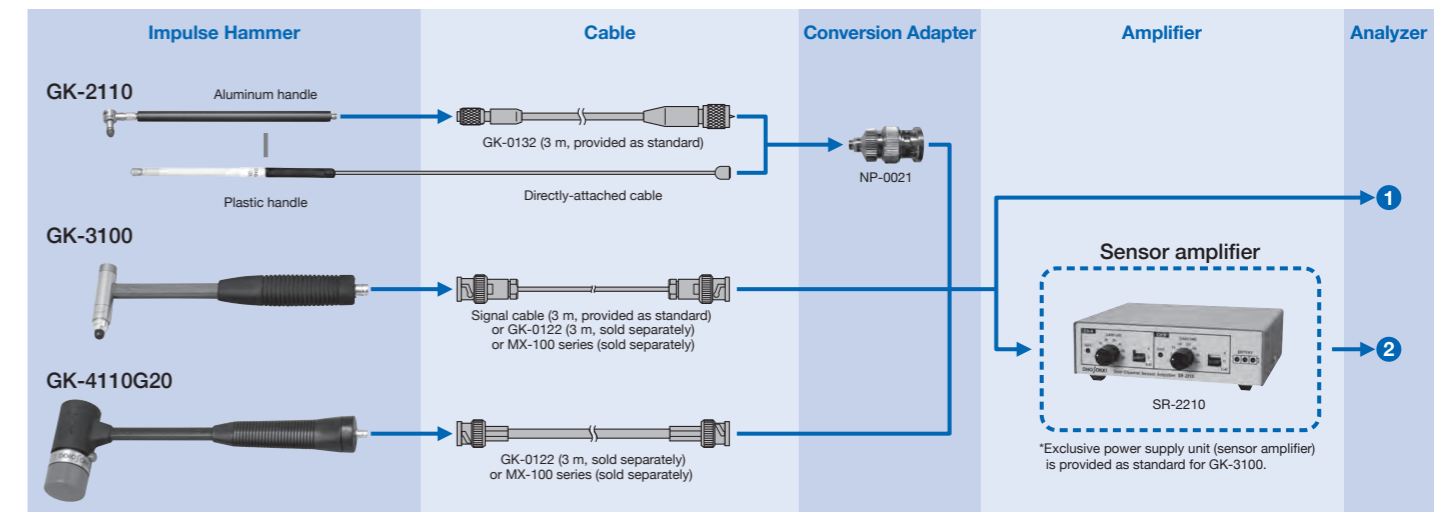

## Analyzers



(1) Voltage input (C02 BNC connector)    (2) Sensor input (C02 BNC connector)\*<sup>1</sup>

\*1: Can not be used with the NP-500 series. (There are some exceptions)  
 \*2: Connects TEDS amplifier and the sensor which is not applicable to TEDS.

# Sensor NP/GK Series

An accelerometer is a sensor that converts mechanical vibrations into electrical signals proportional to the vibratory acceleration. There are several different types of NP Series accelerometers available, such as an ultra-compact type that weighs a mere 0.2 g, a tri-axial type for simultaneous measurement of acceleration in the X, Y, and Z directions, a waterproof type, and a high-sensitive type. Select the type that best meets your application needs. These purpose-designed sensors are capable of high-sensitive detecting mechanical vibration.

## Features

### All the NP Series are Piezoelectric Accelerometers.

1. The NP Series accelerometers are seismic\* vibration detectors, and therefore do not require a reference point for measurement. Measurement is performed simply by mounting the accelerometer to the measured object.
2. Compared to other vibration sensors, the NP Series accelerometers are compact and lightweight, thereby facilitating mounting to a test object. Their small size makes them easy to handle.
3. The wide dynamic range enables the measurement of even ultra-small acceleration levels.
4. The NP Series accelerometers are mechanically robust, and are therefore ideal for measuring a large acceleration and for measuring shock acceleration.
5. In general, the high resonance frequency and the wide range of measurement frequency enable measurement with minimal distortion, even of waveforms containing wideband frequency components.
6. Various types of accelerometers with the performance capabilities are available to suit applications and environmental conditions.

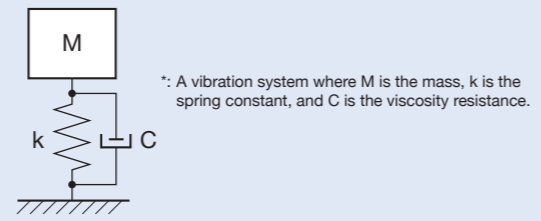

## Piezoelectric Elements and Piezoelectric Accelerometers

### ■ Piezoelectric Element

When force is applied to a single crystal or to barium titanate, an electric charge is generated on its surface. This is called the piezoelectric effect. Materials which exhibit the piezoelectric effect are called piezoelectric materials (piezoelectric elements).

### ■ Piezoelectric Accelerometer

A piezoelectric accelerometer is a sensor that utilizes a piezoelectric element as a seismic spring and also as an electromechanical transducer at the same time. Electrical signals are output in direct proportion to the vibratory acceleration.

### ■ Accelerometer Types: Compressed and Shear

Piezoelectric accelerometers can be basically divided into two types, compressed and shear, depending on how force is applied to the piezoelectric element. Figure 1 shows the respective construction for each of the two types. With the compressed type (a), the piezoelectric element is sandwiched between the sensor base and the inertial mass. With the shear type (b), the piezoelectric element is fixed in place between a post that is placed vertically on the base and the inertial mass. The compressed type was conventionally used in the past, but recently the shear type, which is minimally affected by base strain and sudden variations in temperature, has become more widespread.

Figure 1: Piezoelectric Accelerometer Structure

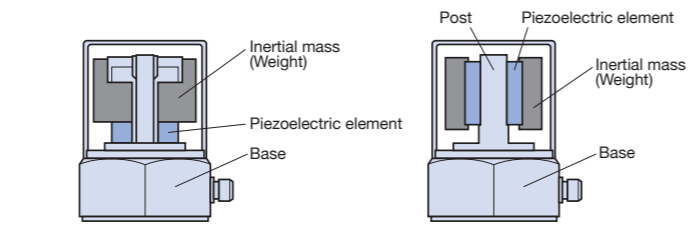

- (a) Compressed type
- Robust against impact force
- (b) Shear type
- Minimally affected by pyroelectric noise and base strain
  - High sensitivity

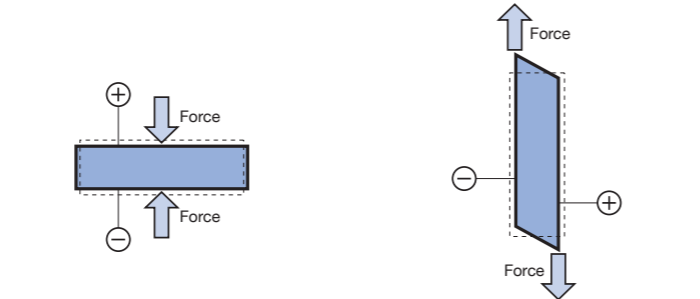

An electric charge is generated when either a compressing force or a pulling force is applied to the piezoelectric element in the axial direction.

An electric charge is generated when force is applied to the piezoelectric element in the shear directions.

## Useful advice

### ■ How to choose; a charge output accelerometer or an accelerometer with built-in preamplifier

Depending on the measurement application, the suitable sensor will be different. Refer to the guidelines below provided to help you make the correct choice; a charge output accelerometer or one with built-in preamplifier.

#### ■ Charge output accelerometer

This type of accelerometer is used for the measurement of vibration from collision, drop, and other similar impact vibrations, and for vibration measurement at high temperatures.

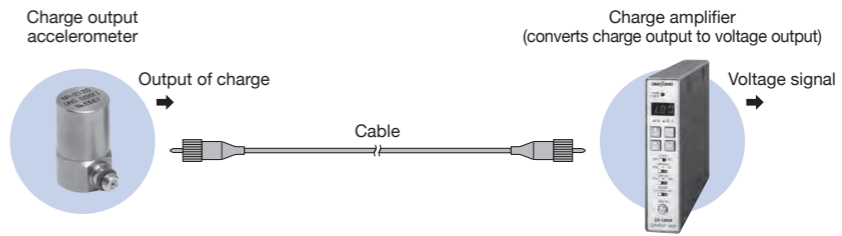

Device	Features
Sensor NP-2000 Series	<ul style="list-style-type: none"> <li>• High performance against impact force.</li> <li>• Can be used at high temperatures.</li> </ul>
Cable	<ul style="list-style-type: none"> <li>• Low-noise cable.</li> <li>• Care must be taken with fixing method of the cable (noise countermeasure).</li> <li>• The cable length can be extended up to approx. 100m. Care must be taken, however, with countermeasure against noise interference.</li> </ul>
Amplifier	<ul style="list-style-type: none"> <li>• Sensitivity settings are required for each sensor.</li> <li>• Care must be taken with the storage location (temperature, humidity, etc.).</li> <li>• Comparatively expensive.</li> </ul>

#### ■ Accelerometer with built-in preamplifier

This type of an accelerometer is used for the measurement of general mechanical vibrations (diagnostic tests on plant equipment and so forth).

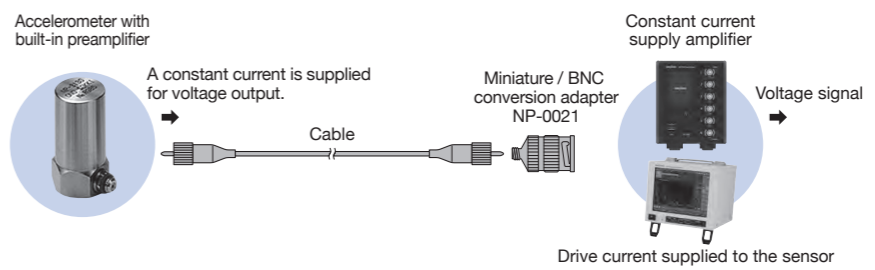

Device	Features
Sensor NP-3000/7000 Series	<ul style="list-style-type: none"> <li>• Compact design, high sensitivity.</li> <li>• Comparatively high noise-withstand capability.</li> </ul>
Cable	<ul style="list-style-type: none"> <li>• Comparatively little affected by noise influence due to shaking of the cable or the like.</li> <li>• The cable length can be extended up to approx. 100m.</li> </ul>
Amplifier	<ul style="list-style-type: none"> <li>• Extremely easy to handle.</li> <li>• Quick start after power supply.</li> <li>• Compact, lightweight design.</li> </ul>

### The influence on the frequency characteristics due to mounting methods

There are several different methods of mounting the accelerometer on the measured object: screw mount, magnet base, adhesive, and so forth. Depending on the mounting method selected, however, the frequency characteristics may be adversely affected.

The figure below shows examples of the frequency characteristics for the various methods used to mount an accelerometer on the measured object.

- (1) Screw mount + silicon oil
- (2) Screw mount
- (3) Magnet base
- (4) Search needle
- (5) Thick double-sided tape
- (6) Thin double-sided tape

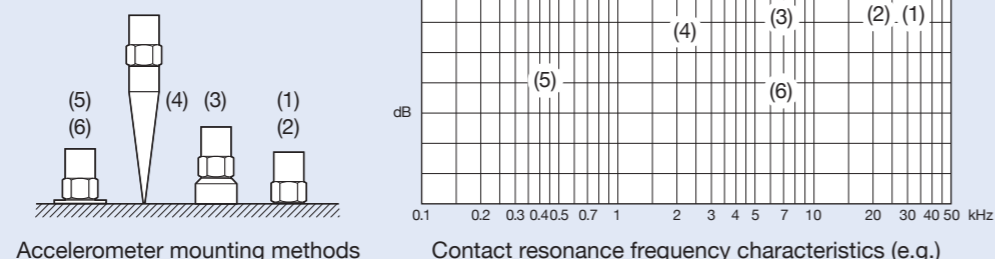

### What is mass effect?

The mass effect is that the natural frequency of the object to be measured is influenced and changed due to the mass of the sensor itself attached for measurement.

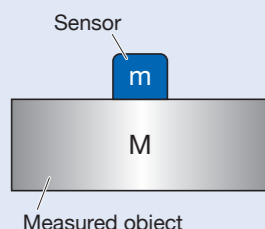

$$\Delta fe = fe \left( 1 - \sqrt{\frac{M}{M+m}} \right)$$

M: Mass of the measured object  
 m: Mass of the sensor  
 $fe$  : Resonant frequency  
 $\Delta fe$  : Resonant frequency deviation

Mass effect refers to the sensor mass ability to affect an object's natural frequency. Because natural frequency depends on mass, an object to which sensor is attached will have a lower natural frequency than that of the object itself. If a sensor mass is too large, the sensor will decrease the object's natural frequency, thus resulting in measurement error. It is recommended that the sensor mass is under one-fiftieth or hundredth of the object's mass. Note that mass is not the mass of the whole object but the mass of the part to which the sensor will be attached. The part may be unexpectedly light weight.

### TEDS function

#### What is TEDS?

TEDS, an abbreviation for Transducer Electronic Data Sheet, is an information description format for sensor-specific information.

Manufacturer ID: 53=ONO SOKKI  
 Model number : 3578N20  
 Serial number : 123456  
 Sensitivity : 10 mV/ (m/s<sup>2</sup>)  
 Axial direction : Z  
 Output polarity: Positive  
 Weight : 11.1g  
 Writable in USER area  
 Measurement location ID: 0021  
 Calibration date : 2022/2/20  
 Calibration frequency : 159.2 Hz  
 Calibration temperature: 23.3 °C

#### Benefits of TEDS

- It reduces initial setting time of the sensor sensitivity by manual data entry.
- TEDS sensor features automatic setting which minimizes human errors such as miss-entry, giving sensor's information including sensitivity and axial direction.
- As it is not required to manage data-sheet individually for each sensor, the work is simplified.

#### TEDS facilitates your measurement process!

TEDS is very helpful not only for the multi-channel, but also single-channel measurement. TEDS prevents occurring serious human error at the time of setup such as sensitivity setup.

##### Conventional procedure for measurement

- 1) Make the correspondent table of measurement points and sensor sensitivities while mounting sensors.
- 2) Tag the both side of cables with careful attention not to make a wrong connection.
- 3) Lay the cables and check the disconnection.
- 4) Connect sensors to amplifiers in order while checking the each tag.
- 5) Setup the sensitivity of amplifier or analyzer.
- 6) Start measurement.

Do you figure out each connection of measurement point and sensor?  
 At multipoint measurement, TEDS greatly helps to reduce the setup time.

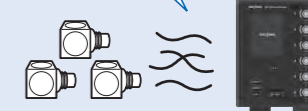

Is the sensitivity setup correct?  
 Also it is effective at single point measurement.



##### Preparation for measurement using TEDS applicable sensors

- 1) Lay the cables.
- 2) Read TEDS information to complete the checking disconnection and setting the sensitivity.
- 3) Start measurement.

### Alternative solutions to make the existing sensor applicable to TEDS

#### NP-0081N20 TEDS Adapter



The NP-0081N20 adapter makes an accelerometer with built-in preamplifier applicable to TEDS. You can use the existing sensor as TEDS applicable sensor only by adding sensor's information such as sensitivity to this adapter. TEDS function is available just by

using NP-0081N20 adapter between the accelerometer and TEDS equipments.

- This adapter easily enables an accelerometer with built-in preamplifier to be TEDS applicable sensor.
- By using this adapter, there is no need to embed TEDS tip in the sensor itself. You can use the sensor as TEDS applicable one while keeping the features of each sensor such as ultra compact and lightweight.

#### Specification

Item	NP-0081N20
Structure	Input output connector connection case ground
Case material	Stainless
Connector	Sensor side : 10-32 Coaxial (miniature connector) Measurement side: C02 (BNC)
Applicable sensor	NP-3000 series (CCLD sensor with built-in preamplifier) *Supplied power voltage to a sensor is reduced 1V by connecting the NP-0081N20. Please be careful for the sensor required power voltage range and required power voltage of the measurement unit to be connected. The maximum applied voltage is +30V.
TEDS information	Refer to this page (What is TEDS?)
Operating temperature range	-40 to +85 °C
Operating humidity range	85 %RH or less
TEDS standard	IEEE 1451.4-2004 (Template Ver.1.0)
Outer dimensions	φ15 × 40 mm
Weight	Approx. 20 g

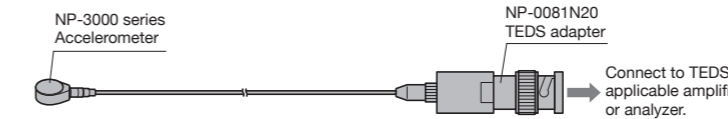

\*The sensor is delivered after matching with NP-0081N20 adapter.

\*The NP-0081N20 TEDS adapter and an accelerometer with built-in amplifier are used in one-on-one combination. The same number of TEDS adapters are required as sensors to be TEDS applicable. (One TEDS adapter cannot be connected to plural accelerometers.) Calibration information of the sensor in combination is written on the TEDS tip of the TEDS adapter. The model name and serial number are written on the sticker of the external case. This adapter is also used with measurement instruments which does not support TEDS.

### CE Marking

#### What is CE marking?









The CE marking on a product indicates that the target product satisfies the requirements on each directive prescribing the health and safety protection of users and consumers of products, which is based on the New Approach Directive (European Common Law) established by the European Commission. To conform to CE marking ensures distribution and selling freely in the European Union, and can be said that it is a proof of trust.



#### Advantages of CE marking products

In the measurement of machines that generate electromagnetic noise such as large motors and engines, it is less affected by noise, and more accurate vibration measurement is possible. The NP-3331B/ NP-3331N30/ NP-3550/ NP-3564N10 are conforming to CE marking.

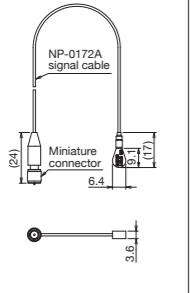
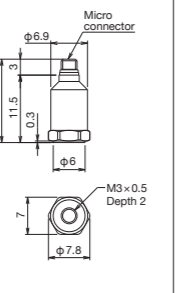
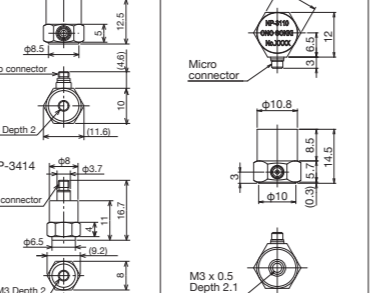
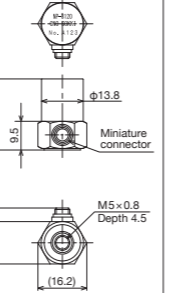
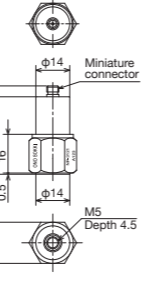
## NP-3000 Series Accelerometers with Built-in Preamp

Features	Ultra-compact and lightweight	Compact and lightweight	Compact and lightweight	Compact and lightweight general-purpose usage	General-purpose usage	General-purpose usage and floating
Structure	Shear type	Shear type	Shear type	Shear type	Shear type	Shear type
Model name	NP-3211	NP-3418	NP-3412-3414	NP-3110	NP-3120	NP-3121
Appearance						
Sensitivity *1	1.02 mV/ (m/s <sup>2</sup> ) ±15 %	1.0 mV/ (m/s <sup>2</sup> ) ±10 %	1.0 mV/ (m/s <sup>2</sup> ) ±1 dB	0.5 mV/ (m/s <sup>2</sup> ) ±1 dB	1.0 mV/ (m/s <sup>2</sup> ) ±1 dB	1.0 mV/ (m/s <sup>2</sup> ) ±1 dB
Resonance frequency	50 kHz or more	Approx. 46 kHz	Approx. 47 kHz	Approx. 45 kHz	Approx. 50 kHz	Approx. 50 kHz
Frequency range	1 Hz to 10 kHz ±5% 0.7 Hz to 13 kHz ±10 % 0.3 Hz to 20 kHz ±3 dB	2 Hz to 6 kHz ±0.5 dB	2 Hz to 8 kHz ±0.5 dB	5 Hz to 6 kHz ±0.5 dB	5 Hz to 5 kHz ±0.5 dB	5 Hz to 5 kHz ±0.5 dB
Maximum allowable acceleration	4,900 m/s <sup>2</sup>	2,200 m/s <sup>2</sup>	2,200 m/s <sup>2</sup>	4,400 m/s <sup>2</sup>	2,200 m/s <sup>2</sup>	2,200 m/s <sup>2</sup>
Maximum shock resistance	98,000 m/s <sup>2</sup>	10,000 m/s <sup>2</sup>	10,000 m/s <sup>2</sup>	100,000 m/s <sup>2</sup>	100,000 m/s <sup>2</sup>	10,000 m/s <sup>2</sup>
Operating temperature range	-54 to +121 °C	-30 to +110 °C	-30 to +110 °C	-20 to +110 °C	-20 to +110 °C	-20 to +110 °C
Output impedance	300 Ω or less	100 Ω or less	100 Ω or less	100 Ω or less	100 Ω or less	100 Ω or less
Detector noise	Approx. 20 μVrms Approx. 0.02 m/s <sup>2</sup> rms	20 μVrms or less 0.02 m/s <sup>2</sup> rms or less	20 μVrms or less 0.02 m/s <sup>2</sup> rms or less	20 μVrms or less 0.04 m/s <sup>2</sup> rms or less	20 μVrms or less 0.02 m/s <sup>2</sup> rms or less	20 μVrms or less 0.02 m/s <sup>2</sup> rms or less
Power requirement	18 to 30 VDC 2 to 20 mA Constant current drive	15 to 25 VDC 0.5 to 5 mA Constant current drive	15 to 25 VDC 0.5 to 5 mA Constant current drive	12 to 25 VDC 0.5 to 5 mA Constant current drive	15 to 25 VDC 0.5 to 5 mA Constant current drive	15 to 25 VDC 0.5 to 5 mA Constant current drive
Weight	0.5 g	1.9 g	NP-3412: 5.5 g NP-3414: 3.5 g	5.4 g	20 g	34 g
Ground/Insulation	Case ground (surface insulation)	Case ground	Case ground	Case ground	Case ground	Mounting surface insulation
Case material	Aluminum	Titanium	SUS303	Titanium	SUS303	SUS303
Connector	3-56 coaxial Side	M3 coaxial (micro connector) Top	M3 coaxial (micro connector) NP-3412: Side NP-3414: Top	M3 coaxial (micro connector) Side	10-32 coaxial (miniature connector) Side	10-32 coaxial (miniature connector) Top
Compatible cable	NP-0172A (provided)	NP-0150 Series	NP-0150 Series	NP-0150 Series	NP-0120/0130 Series	NP-0120/0130 Series
Mouting method	Adhesive	M3 female screw	M3 female screw	M3 female screw	M5 female screw	M5 female screw
Accessories	NP-0172A (3 m cable) NP-0021 (BNC to 10-32 conversion adapter) Tool for removing, Mounting wax Instruction manual, Calibration chart	M5 × 0.5 L = 4 set screw Instruction manual Calibration chart	M5 × 0.5 L = 4 set screw Instruction manual Calibration chart	M5 × 0.5 L = 5 set screw Exclusive 3 m cable Instruction manual Calibration chart	M5 × 0.8 L = 10 set screw Instruction manual Calibration chart	M5 × 0.8 L = 10 set screw Instruction manual Calibration chart
Outer dimension *7 (Unit: mm)	φ6.4 × 3.6 H 	7 Hex × 11.5 H 	NP-3412: 10 Hex × 12.5 H NP-3414: 8 Hex × 11 H 	11 Hex × 14.5 H 	14 Hex × 23.5 H 	17 Hex × 32 H 

\*1: The sensitivity varies depending on the model (individual differences).  
The values given in the above table are the standard values at the time of shipment, not the measurement accuracy values.  
Performing calibration for each of the sensor according to its respective sensitivity value enables measurement to be performed under the same conditions and with the same accuracy, irrespective of the sensor type.

\*2: When the sensor is used in the place where there is splash or spilled water, please refer to the lowermost section of page13 for water-resistant processing.





\*3: Conforms to IEEE1451.4-2004 Template ver. 1.0

\*4: Applicable standard EN61326-1: 2006

\*5: Conforms to JIS C 0920 2003 Protection Class 7.

\*6: The cable is not included.

\*7: Connector and cable parts are not included.

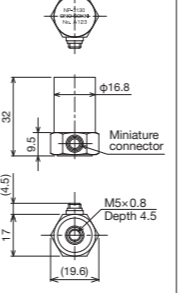
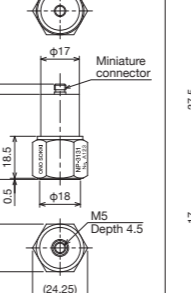
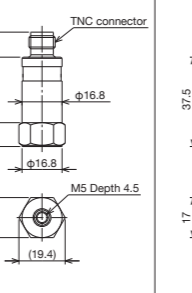
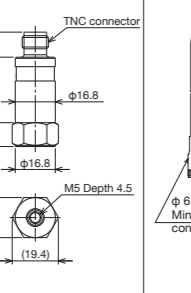
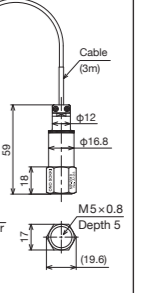
Features	High-sensitivity	High-sensitivity and floating	Floating and water resistance type*2	Floating and water resistance type*2 (TEDS*3)	Waterproof *5
Structure	Shear type	Shear type	Shear type	Shear type	Shear type
Model name	NP-3130	NP-3131	NP-3331B	NP-3331N30	NP-3310
Appearance					
Sensitivity *1	10 mV/ (m/s <sup>2</sup> ) ±1 dB	10 mV/ (m/s <sup>2</sup> ) ±1 dB	5.0 mV/ (m/s <sup>2</sup> ) ±10 %	5.0 mV/ (m/s <sup>2</sup> ) ±10 %	1.0 mV/ (m/s <sup>2</sup> ) ±1 dB
Resonance frequency	Approx. 25 kHz	Approx. 25 kHz	Approx. 27 kHz	Approx. 27 kHz	Approx. 35 kHz
Frequency range	5 Hz to 4 kHz ±0.5dB 5 Hz to 10 kHz ±3 dB	5 Hz to 4 kHz ±0.5dB 5 Hz to 8 kHz ±3 dB	2 Hz to 4 kHz ±5 % 2 Hz to 10 kHz ±3 dB	2 Hz to 4 kHz ±5 % 2 Hz to 10 kHz ±3 dB	5 Hz to 5 kHz ±0.5 dB 5 Hz to 10 kHz ±3 dB
Maximum allowable acceleration	220 m/s <sup>2</sup>	220 m/s <sup>2</sup>	700 m/s <sup>2</sup>	700 m/s <sup>2</sup>	2,200 m/s <sup>2</sup>
Maximum shock resistance	100,000 m/s <sup>2</sup>	5,000 m/s <sup>2</sup>	10,000 m/s <sup>2</sup>	10,000 m/s <sup>2</sup>	10,000 m/s <sup>2</sup>
Operating temperature range	-20 to +110 °C	-20 to +110 °C	-20 to +110 °C	-20 to +85 °C	-20 to +80 °C
Output impedance	100 Ω or less	100 Ω or less	100 Ω or less	300 Ω or less	100 Ω or less
Detector noise	20 μVrms or less 0.002 m/s <sup>2</sup> rms or less	20 μVrms or less 0.002 m/s <sup>2</sup> rms or less	20 μVrms or less 0.004 m/s <sup>2</sup> rms or less	20 μVrms or less 0.004 m/s <sup>2</sup> rms or less	20 μVrms or less 0.02 m/s <sup>2</sup> rms or less
Power requirement	15 to 25 VDC 0.5 to 5 mA Constant current drive	15 to 25 VDC 0.5 to 5 mA Constant current drive	15 to 25 VDC 0.5 to 5 mA Constant current drive	18 to 25 VDC 0.5 to 5 mA Constant current drive	15 to 25 VDC 0.5 to 5 mA Constant current drive
Weight	46 g	69 g	50 g	50 g	59 g*6
Ground/Insulation	Case ground	Mounting surface insulation	Case insulation	Case insulation	Case insulation
Case material	SUS303	SUS303	SUS303	SUS303	SUS303
Connector	10-32 coaxial (miniature connector) Side	10-32 coaxial (miniature connector) Top	TNC Top	TNC Top	Attached to the cable (3 m) 10-32 coaxial plug (miniature connector)
Compatible cable	NP-0120/0130 Series	NP-0120/0130 Series	NP-0140 Series	NP-0140 Series	-
Mouting method	M5 female screw	M5 female screw	M5 female screw	M5 female screw	M5 female screw
Accessories	M5 × 0.8 L = 10 set screw Instruction manual Calibration chart	M5 × 0.8 L = 10 set screw Instruction manual Calibration chart	M5 × 0.8 L = 10 set screw Instruction manual Calibration chart	M5 × 0.8 L = 10 set screw Instruction manual Calibration chart	M5 × 0.8 L = 10 set screw Instruction manual Calibration chart
Outer dimension *7 (Unit: mm)	17 Hex × 32 H 	21 Hex × 37.5 H 	17 Hex × 37.5 H 	17 Hex × 37.5 H 	17 Hex × 59 H 

\*1: The sensitivity varies depending on the model (individual differences).  
The values given in the above table are the standard values at the time of shipment, not the measurement accuracy values.  
Performing calibration for each of the sensor according to its respective sensitivity value enables measurement to be performed under the same conditions and with the same accuracy, irrespective of the sensor type.

\*2: When the sensor is used in the place where there is splash or spilled water, please refer to the lowermost section of page13 for water-resistant processing.

\*3: Conforms to IEEE1451.4-2004 Template ver. 1.0





\*4: Applicable standard EN61326-1: 2006

\*5: Conforms to JIS C 0920 2003 Protection Class 7.



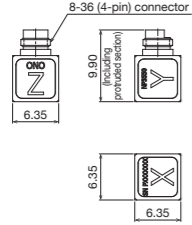
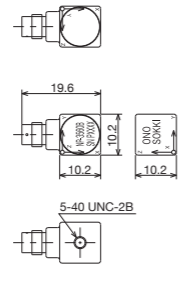
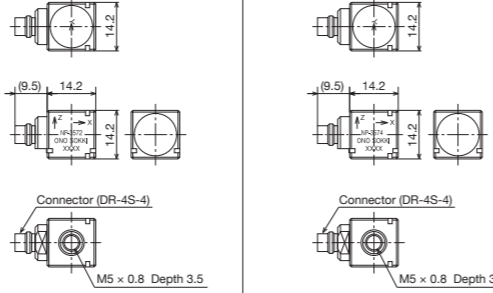

\*6: The cable is not included.

\*7: Connector and cable parts are not included.

## Tri-axial Accelerometers with Built-in Preamp / Charge Output Type

Features	Tri-axial accelerometer with Built-in preamplifier			
	Ultra-compact	Compact and tri-axis	General-purpose and tri-axis	General-purpose and tri-axis
Structure	Shear type	Shear type	Shear type	Shear type
Model name	NP-3550	NP-3560B	NP-3572	NP-3574
Appearance				
Sensitivity *1	1.02 mV/(m/s <sup>2</sup> ) ±20 %	1.02 mV/(m/s <sup>2</sup> ) ±10 %	1.0 mV/(m/s <sup>2</sup> ) ±10 %	10 mV/(m/s <sup>2</sup> ) ±10 %
Capacitance	-	-	-	-
Resonance frequency	50 kHz or more	Approx. 55 kHz or more	15 kHz or more (X axis) Approx. 45 kHz ±5 (Y, Z axis)	
Frequency range	2 to 5 kHz ±5 % (X axis) 2 to 8 kHz ±5 % (Y, Z axis)	2 Hz to 5 kHz ±5 % (X axis) 2 Hz to 10 kHz ±5 % (Y, Z axis)	1 Hz to 5 kHz ±10 % (X, Y axis) 1 Hz to 8 kHz ±10 % (Z axis)	
Maximum allowable acceleration	4,905 m/s <sup>2</sup>	4,900 m/s <sup>2</sup>	4,000 m/s <sup>2</sup>	400 m/s <sup>2</sup>
Maximum shock resistance	49,050 m/s <sup>2</sup> or more	98,100 m/s <sup>2</sup>	30,000 m/s <sup>2</sup>	
Operating temperature range	-54 to +121 °C	-54 to +121 °C	-50 to +110 °C	
Output impedance	200 Ω or less	200 Ω or less	1 kΩ or less	
Detector noise	30 μVrms (typ) 0.03 m/s <sup>2</sup> rms (typ)	30 μVrms (typ) 0.03 m/s <sup>2</sup> rms (typ)	40 μVrms or less 0.04 m/s <sup>2</sup> rms or less	40 μVrms or less 0.004 m/s <sup>2</sup> rms or less
Power requirement	22 to 30 V DC 2 to 20 mA Constant current drive	18 to 30 VDC 2 to 20 mA Constant current drive	21 to 30 VDC 0.5 to 5 mA Constant current drive	
Insulation resistance	-	-	-	
Weight	1.0 g	5.3 g	8.1 g	
Ground/Insulation	Case ground	Case ground	Case ground	
Case material	Titanium	Titanium	Aluminum	
Connector	8-36 (4-pin) Side	1/4-28 (4-pin) connector Side	DR-4S-4 Side	
Compatible cable	NP-0272	NP-0252, 0262	NP-0222, 0232	
Mouting method	Adhesive	Adhesive or 5-40UNC female screw	Adhesive mounting clip or M5 female screw	
Accessories	Calibration chart Instruction manual Mounting wax	5-40UNC/M3 Conversion screw (×2) Mounting wax Mounting base (NP-0035) Instruction manual Calibration chart	M5 × 0.8 L = 8 set screw Mounting wax Mounting clip (NP-0061) Instruction manual Calibration chart	
Outer dimension*5 (Unit: mm)	6.35(W) × 6.35(D) × 6.35(H) mm 	10.2(W) × 10.2(D) × 10.2(H) mm 	14.2(W) × 14.2(D) × 14.2(H) mm 	

\*1: The sensitivity varies from model to model (individual differences). The values given in the above table are the standard values at the time of shipment, not the measurement accuracy values. Performing calibration for each of the sensor according to its respective sensitivity value enables measurement to be performed under the same conditions and with the same accuracy, irrespective of the sensor type.  
 \*2: Conforms to IEEE1451.4-2004 Template ver. 1.0  
 \*3: Not including the cable.  
 \*4: TEDS communication: -40 to +85 °C  
 \*5: Not including the connector and cable.

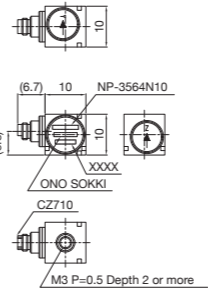
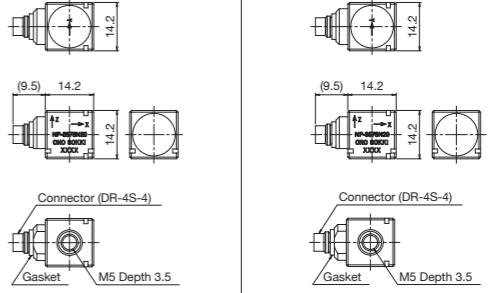
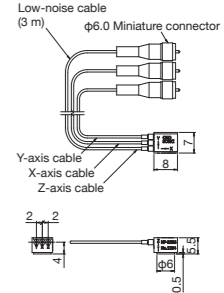
Features	Tri-axial accelerometer with Built-in preamplifier			Charge output
	Compact and tri-axis (TEDS*2)	General-purpose and tri-axis (TEDS*2)	General-purpose and tri-axis (TEDS*2)	Ultra-compact and tri-axis
Structure	Shear type	Shear type	Shear type	Shear type
Model name	NP-3564N10	NP-3576N20	NP-3578N20	NP-2506
Appearance				
Sensitivity *1	10 mV/(m/s <sup>2</sup> ) ±10 %	1.0 mV/(m/s <sup>2</sup> ) ±10 %	10 mV/(m/s <sup>2</sup> ) ±10 %	0.04 pC/(m/s <sup>2</sup> ) ±20 %
Capacitance	-	-	-	580 pF ±20 % (including cable)
Resonance frequency	55 kHz or more (Z axis)	16 kHz or more (X axis) Approx. 47 kHz ±5 (Y, Z axis)		60 kHz or more
Frequency range	2 to 7 kHz ±5 % (X, Y-axis) 2 to 10 kHz ±5 % (Z-axis) 0.5 to 10 kHz ±3 dB (X, Y-axis) 0.5 to 18 kHz ±3 dB (Z-axis)	1 Hz to 5 kHz ±1 dB (X axis) 1 Hz to 8 kHz ±1 dB (Y, Z axis) 0.8 Hz to 8 kHz ±3 dB (X axis) 0.8 Hz to 10 kHz ±3 dB (Y, Z axis)		<Common to X, Y, Z axis> fc to 1 kHz (±5 %) fc to 5 kHz (±10 %) fc to 20 kHz (±3 dB)
Maximum allowable acceleration	450 m/s <sup>2</sup>	3,600 m/s <sup>2</sup>	360 m/s <sup>2</sup>	25,000 m/s <sup>2</sup>
Maximum shock resistance	30,000 m/s <sup>2</sup> or more	30,000 m/s <sup>2</sup>		50,000 m/s <sup>2</sup>
Operating temperature range	-50 to +110 °C*4	-40 to +85 °C		-50 to +160 °C
Output impedance	500 Ω or less	400 kΩ or less	1 kΩ or less	-
Detector noise	40 μVrms or less 0.004 m/s <sup>2</sup> rms or less	40 μVrms or less 0.04 m/s <sup>2</sup> rms or less	40 μVrms or less 0.004 m/s <sup>2</sup> rms or less	-
Power requirement	21 to 30 V DC 2 to 5 mA Constant current drive	18 to 25 VDC 0.5 to 5 mA Constant current drive		-
Insulation resistance	-	-	-	10,000 MΩ or more (50 VDC)
Weight	4.4 g	11.1 g		1.2 g *3
Ground/Insulation	Case ground	Case ground		Case ground
Case material	Titanium	Titanium		Titanium
Connector	CZ710 Side	DR-4S-4 Side		Attached to the cable (3 m, 3 pcs.) Cable diameter φ0.8 mm 10-32 coaxial plug (miniature connector)
Compatible cable	NP-0332/0322	NP-0222, 0232		-
Mouting method	Adhesive, mounting clip or M3 female screw	Adhesive mounting clip or M5 female screw		Adhesive
Accessories	M3 × 0.5 L = 4 screw Mounting clip (NP-0062) Calibration chart Instruction manual Mounting wax	M5 × 0.8 L = 8 set screw Mounting wax Mounting clip (NP-0061) Instruction manual Calibration chart		Instruction manual Calibration chart
Outer dimension*5 (Unit: mm)	10(W) × 10(D) × 10(H) mm 	14.2(W) × 14.2(D) × 14.2(H) mm 		8(W) × 7(D) × 5.5(H) mm 

## NP-2000 Series Charge Output Accelerometers

Features	Ultra-compact and lightweight	Compact and lightweight	Compact and high-temperature proof	Compact and general-purpose usage	Compact	General-purpose usage
Structure	Shear type	Shear type	Shear type	Shear type	Shear type	Shear type
Model name	NP-2106	NP-2110	NP-2710	NP-2910	NP-2810	NP-2120
Appearance						
Sensitivity *1	0.035 pC/ (m/s <sup>2</sup> ) ±20 %	0.16 pC/ (m/s <sup>2</sup> ) ±2 dB	0.306 pC/ (m/s <sup>2</sup> ) ±10 %	0.3 pC/ (m/s <sup>2</sup> ) ±20 %	1.2 pC/ (m/s <sup>2</sup> ) ±2 dB	5 pC/ (m/s <sup>2</sup> ) ±2 dB
Capacitance	580 pF ±20 % (including cable)	700 pF ±20 % (including cable)	Approx. 485 pF	500 pF ±20 %	750 pF ±20 %	3,350 pF ±20 %
Resonance frequency	60 kHz or more	Approx. 46 kHz	Approx. 50 kHz	Approx. 63 kHz	Approx. 48 kHz	Approx. 32 kHz
Frequency range *2	fc to 1 kHz ±5 % fc to 6 kHz ±10 % fc to 20 kHz ±3 dB	fc to 10 kHz ±0.5 dB fc to 20 kHz ±3 dB	fc to 10 kHz ±5 % fc to 20 kHz ±3 dB	fc to 10 kHz ±0.5 dB fc to 20 kHz ±3 dB	fc to 6 kHz ±0.5 dB fc to 15 kHz ±3 dB	fc to 5 kHz ±0.5 dB fc to 12 kHz ±3 dB
Maximum allowable acceleration	100,000 m/s <sup>2</sup>	10,000 m/s <sup>2</sup>	22,600 m/s <sup>2</sup>	50,000 m/s <sup>2</sup>	20,000 m/s <sup>2</sup>	8,000 m/s <sup>2</sup>
Maximum shock resistance	100,000 m/s <sup>2</sup>	100,000 m/s <sup>2</sup>	98,100 m/s <sup>2</sup>	100,000 m/s <sup>2</sup>	30,000 m/s <sup>2</sup>	16,000 m/s <sup>2</sup>
Operating temperature range	-50 to +160 °C	-20 to +160 °C	-71 to +260 °C	-20 to +160 °C	-20 to +160 °C	-20 to +140 °C
Insulation resistance	10,000 MΩ or more (50VDC)	10,000 MΩ or more	1,000 GΩ or more	10,000 MΩ or more	10,000 MΩ or more	10,000 MΩ or more
Weight	0.2 g *3	0.6 g *3	2 g	2 g	12 g	25 g
Ground/Insulation	Case ground	Case ground	Case ground	Case ground	Case ground	Case ground
Case material	Titanium	Titanium	Titanium	Titanium	SUS303	SUS303
Connector	Attached to the cable (3 m) Cable diameter φ0.8 mm 10-32 coaxial plug (miniature connector)	Attached to the cable (3 m) Cable diameter φ1.0 mm 10-32 coaxial plug (miniature connector)	5-44 coaxial Side	M3 coaxial (micro connector) Side	10-32 coaxial (miniature connector) Top	10-32 coaxial (miniature connector) Side
Compatible cable	-	-	NP-0160 Series	NP-0150 Series	NP-0120/0130 Series	NP-0120/0130 Series
Mouting method	Adhesive	Adhesive	M3 male screw	Adhesive	M5 male screw	M5 female screw
Accessories	Tool for scooping out Instruction manual Calibration chart	Instruction manual Calibration chart	NP-0162 cable (3 m) Instruction manual Calibration chart	NP-0152A cable (3 m) Instruction manual Calibration chart	Mounting base (NP-031) Instruction manual Calibration chart	M5 × 0.8L=10 set screw Instruction manual Calibration chart
Outer dimension *4 (Unit: mm)	φ3.5 × 2.5 H 	φ6.5 × 3.7 H 	7.9 Hex × 8.4 H 	7 Hex × 10 H 	12 Hex × 16 H 	14 Hex × 23.5 H 

\*1: The sensitivity varies depending on the model (individual differences). The values given in the above table are the standard values at the time of shipment, not the measurement accuracy values. Performing calibration for each of the sensor according to its respective sensitivity value enables measurement to be performed under the same conditions and with the same accuracy, irrespective of the sensor type.

\*2: The fc value is determined by the time constant with respect to the charge amplifier. For example, when using the NP-2120 together with the CH-1200A, the fc value is 1 Hz (±0.5 dB range).

\*3: The cable is not included.

\*4: Connector and cable parts are not included.

\* The noise specification for the NP-2000 Series accelerometers is the input conversion noise level of the CH-1200A or other charge amplifier used.

### Compatible sensor amplifiers

For NP-3000/7000 series		For NP-2000 series	
Constant current drive amplifier type		Charge amplifier type	
2ch Sensor amplifier	3ch Sensor amplifier	Charge converter	Charge amplifier
SR-2210 	PS-1300 	CH-6130/6140 	CH-1200A 

## NP Series Accessories

### Sensor Signal Cable

Model name	Length (ℓ)	Specifications	Outer dimensions (mm)	Compatible Sensor Models
NP-0121	1.5 m	Operating temperature range: -25 to +105 °C Cable diameter: φ1.2 mm Type: Low-noise cable		NP-2120, 2810, 3120, 3121, 3130, 3131, 550 (NP-2130, 3910*2, 510, 510I, 520, 520I, 560*2, 602*1)*3
NP-0122	3 m			
NP-0123	5 m			
NP-0124	10 m			
NP-0131	1.5 m	Operating temperature range: -73 to +260 °C Cable diameter: φ2.3 mm Type: Low-noise cable		NP-2120, 2810, 3120, 3121, 3130, 3131, 550 (NP-2130, 3910*2, 510, 510I, 520, 520I, 560*2, 602*1)*3
NP-0132	3 m			
NP-0133	5 m			
NP-0134	10 m			
NP-0143	5 m	Operating temperature range: -20 to 110 °C Cable diameter: φ4.2 mm		NP-3331B, 3331N30 (NP-3331, 3331A, 3331N20)*3
NP-0144	10 m			
NP-0146	20 m			
NP-0148	30 m			
NP-0151A	1.5 m	Operating temperature range: Micro connector : -20 to 160 °C Miniature connector: -20 to 110 °C Cable diameter: φ1.2 mm Type: Low-noise cable		NP-2910*1, 3110*1, 3412, 3414, 3418
NP-0152A	3 m			
NP-0153A	5 m			
NP-0154A	10 m			
NP-0162	3 m	Operating temperature range: -90 to +260 °C Cable diameter: φ2.0 mm Type: Low-noise cable		NP-2710
NP-0164	9 m			
NP-0172A	3 m	Operating temperature range: -90 to +260 °C Cable diameter: φ1.1 mm		NP-3211*1
NP-0222	3 m	Operating temperature range: Section A: -51 to +125 °C Section B: -20 to +60 °C Cable diameter Section A: φ2.6 mm Section B: φ2.1 mm		NP-3560*3/3572/3574/3576N10*3 /3576N20/3578N10*3/3578N20
NP-0232				
NP-0213	5 m	Operating temperature range: -51 to +125 °C Cable diameter: φ2.6 mm		Extension cable for NP-3560*3/3572/3574/3576N10*3 /3576N20/3578N10*3/3578N20
NP-0214	10 m			
NP-0252	3 m	Operating temperature range: -90 to +200 °C Cable diameter Section A: φ2.54 mm Section B: φ1.96 mm		NP-3560A*3/3560B
NP-0262				
NP-0243	6 m	Operating temperature range: -90 to +200 °C Cable diameter: φ2.54 mm		Extension cable for NP-3560A*3/3560B
NP-0073*4	0.4 m	Operating temperature range: -10 to +50 °C Cable diameter: φ2.5 mm		Branch cable for NP-7310 (Made to order)

\*1: The cable is provided with the sensor as standard. \*2: The NP-0021 Miniature/BNC conversion adapter is required. \*3: Models discontinued.

\*4: The cable is provided with the NP-7310 as standard.

### [Application]

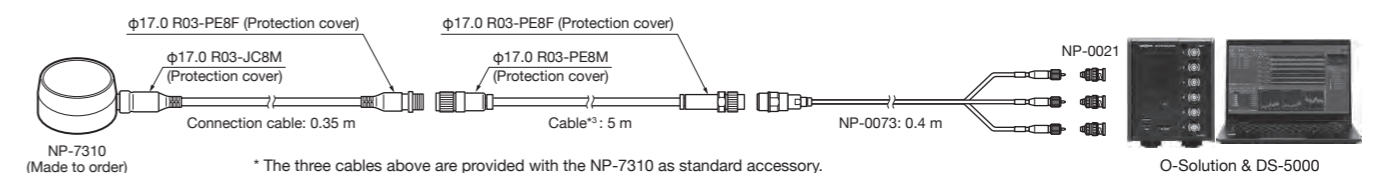

## NP Series Accessories

### Sensor Signal Cable

Model name	Length (ℓ)	Specifications	Outer dimensions (mm)	Compatible Sensor Models
NP-0322	3.3 m	Operating temperature range: A: -50 to +120°C B: -20 to +60°C Cable diameter: A: φ2.0 mm B: φ2.1 mm		NP-3564N10
NP-0332	3.3 m	Operating temperature range: A: -50 to +120°C B: -20 to +60°C Cable diameter: A: φ2.0 mm B: φ2.1 mm		NP-3564N10
NP-0313	5 m	Operating temperature range: -50 to +120°C Cable diameter: φ2.0 mm		Extension cable for NP-3564N10
NP-0314	10 m			
NP-0272	3 m	Operating temperature range A: -90 to +200 °C B: -90 to +204°C Cable diameter A: φ1.96 mm B: φ1.9 mm		NP-3550
NP-0273	6.1 m	Operating temperature range: A: -60 to +260°C B: -90 to +204°C Cable diameter: A: φ1.8 mm B: φ1.9 mm		NP-3550
NP-0274	9.1 m	Operating temperature range A: -90 to +200 °C B: -90 to +204°C Cable diameter A: φ1.96 mm B: φ1.9 mm		NP-3550
NP-0291	1.5 m	Operating temperature range: -90 to +200°C Cable diameter: φ1.96 mm		Conversion cable for NP-3550 when using NP-0252/ 0262/ 0243

#### [Application]

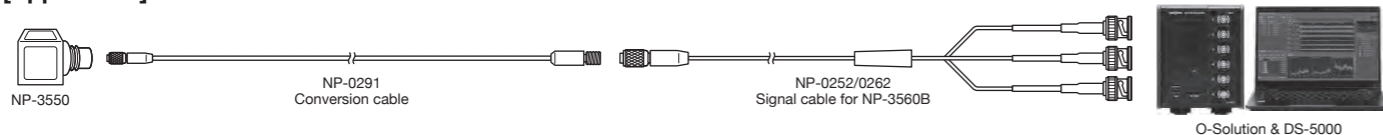

### Signal Cable Extension Adapter

Model Name	Outer dimensions (mm)	Usage Example
NP-0020		

### BNC/Miniature Conversion Adapter

Model Name	Outer dimensions (mm)	Usage Example
NP-0021		

### Magnet Base

Model Name	NP-0100	NP-0101	NP-0102
Dimensional drawing			
Specifications	Weight: 22 g Force : 120 N	Weight: 12 g Force : 30 N	Weight: 10 g Force : 30 N
Compatible Sensors	NP-3130, 3131, 3310, 3331B, 3331N30 (NP-2130, 4120, 520, 520I, 3331N20)*	NP-2120, 3120, 3121, 3572, 3574, 3576N20, 3578N20 (NP-3910, 510, 510I, 3576N10, 3578N10)*	NP-3110, 3412, 3414, 3418 Note: If the NP-0042 flat table is used, the NP-0102 magnet base can also be used with the NP-2110, 2910, 3211, 3560B, (NP-3210, 3560A, 602)* sensors.
Model Name	NP-0103	NP-0104	NP-032
Dimensional drawing			
Specifications	Weight: 2.2 g Force : 4.0 N	Weight: 4.5 g Force : 40 N	Weight: 34 g Force : 40 N
Compatible Sensors	NP-3412, 3414, 3418	NP-3564N10	NP-2120, 2810, 3120, 3121, 3130, 3131, 3310, (NP-2130, 3910, 510, 510I, 520, 520I)*

Note: Operating temperature range: -20 to +100 °C

### Search Needle

Model Name	Outer dimensions (mm)	Compatible Sensors
NP-033 (Made to order)		NP-500/2000/3000 Series (excluding the NP-2106, 2110, 2506, 2710, 2910, 3110, 3210*, 3211, 3230*, 3412, 3414, 3418, NP-3000 series tri-axial type)

#### [ Application ]

Use the NP-033 Search needle when there are multiple measurement points; when area for mounting a sensor is too confined; or when there are other difficulties faced when performing measurement.

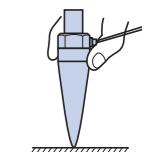

### Mounting Base

Model Name	Outer dimensions (mm)	Compatible Sensors
NP-031		NP-500/2000/3000 Series (excluding the NP-2106, 2110, 2506, 2710, 2910, 3110, 3211, 3412, 3414, 3418, 3560B, 3210*, 3230*, 3560*, 3560A* models)
NP-0032		NP-2710, 3418, 3560B, 3560A*
NP-0035		NP-2710, 3418, 3560B, 3560A*

#### [ Application ]

Use a mounting base when you want to protect the bottom surface of a sensor. The base enables a sensor to be mounted on and removed from a test object without scratching the bottom of the sensor.

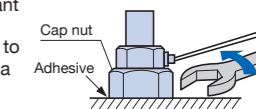

Models with \* have been already discontinued.



## NP Series Accessories

Models with \* have been already discontinued.

### Mounting Clip

Model Name	Outer dimensions (mm)	Compatible Sensors
NP-0061	<p>Material: ABS resin Weight: Approx. 1.7 g</p>	NP-3572/3574/3576N20/ 3578N20 (NP-3576N10/ 3578N10)*
NP-0062		NP-3564N10

#### [ Application ]

Using mounting clip prevents an accident that threaded screw hole is filled with adhesive or NP sensor is broken by the excessive load at the time of dismount. Also mounting clips at several points on the measurement object makes NP sensor easy to move over and results in reducing setup time.

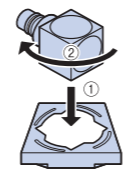

### Conversion Screw

Model Name	Outer dimensions (mm)	Compatible Sensors
NP-0051	<p>Material: Beryllium copper Weight: Approx. 0.2 g</p>	NP-3560B, 3560A*

#### [ Application ]

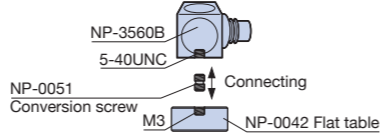

### Flat Table

Model Name	Outer dimensions (mm)	Compatible Sensors
NP-0042	<p>Material: SUS304 Weight: Approx. 7.8 g</p>	NP-2110, 2910, 3211, 3560B, (NP-3210, 3560A, 602)*

#### [ Application ]

Use the flat table when you want to mount the NP-2110, 2910, 3211, 3560B, (NP-3210, 3560A, 602)\* sensors on a magnet base.

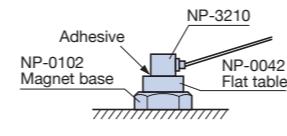

### Wax

Model Name	Appearance
NP-0010	<p>Contains approx. 20 ml</p>

#### [ Application ]

Use the wax to mount the sensor on the measurement object.

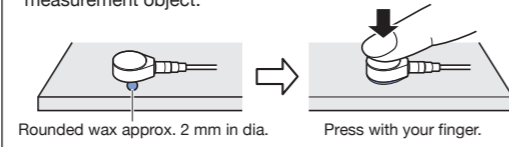

- The frequency characteristics will vary according to the mounting method of wax. Please contact your nearest distributor or our sales office nearby for further details.
- Please use the wax at room temperature. The wax may melt down at high temperature and it causes adhesion failure.

### For water-resistance processing of NP-3331B/3331N30

When NP-3331B/3331N30 are used in where the sensor may be splashed or spilled water, please refer to the procedure to handle as follows. (Equivalent of IPX 7)

**Attention: Please make this modification at your own responsibility. The failures or troubles occurring through modification will be handled on a fee basis even during the warranty period. For modification (fare-paying service), contact your nearest distributor or our sales office nearby.**

- Attach the TNC plug of the exclusive cable (NP-0140 series) to the sensor.
- Apply entirely the silicon rubber adhesive (sealing agent) to the cable part where is put on a rubber cover of NP-0140, connector part and sensor part.
  - Recommended manufacturer of sealing agent: Shin-Etsu Chemical Co., Ltd
- Shift the water-proof rubber cover to the specified position.
- Harden the sealing agent adequately.

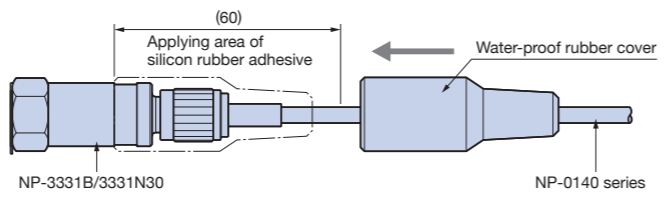

## GK Series Impulse Hammer

### GK Series Impulse Hammer

The GK series Impulse Hammer is an excitation hammer with a built-in force sensor used for natural frequency measurement and mode analysis of structures.

When you hit the object to be analyzed with an impulse hammer, you can apply an excitation force to a flat wide frequency band and simultaneously detect the excitation force by hitting. You can select an appropriate model according to the size of analysis target and analysis frequency range.

- Frequency response function measurement (natural frequency measurement) and damping ratio can be measured using FFT Analyzer.
- By processing the obtained frequency response function with mode analysis software, the vibration mode of the structure can be visualized.

#### [ Application ]

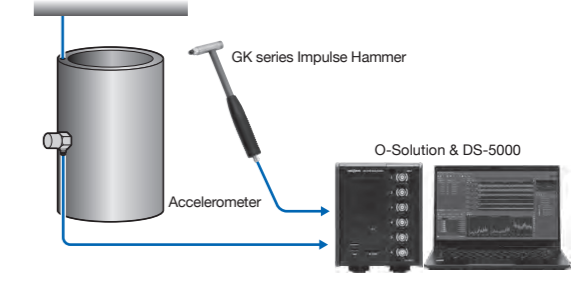

#### Specification

Model name	GK-2110	GK-3100	GK-4110G20
Appearance			
Measurement range	220 N	2,200 N	22,000 N
Detection element	Crystal	Crystal	Crystal
Sensor sensitivity	22.5 mV/N	2.3 mV/N	0.23 mV/N
Sensor resonance frequency	100 kHz or more	31 kHz or more	12 kHz or more
Excitation frequency range (when hard tip in use)	Up to 20 kHz	Up to 8 kHz	Up to 1 kHz
Hammer weight	Approx. 4.8 g (when attached with a plastic hammer handle)	Approx. 140 g	Approx. 1,100 g
Head diameter	6.3 mm	15 mm	51 mm
Tip diameter	2.5 mm	6.3 mm	51 mm
Hammer length	107 mm	203 mm	370 mm
Outer dimensions	See P.20	See P.20	See P.20
Output connector	Aluminum hammer handle (5-44 coaxial connector) Plastic hammer handle (directly-attached cable, miniature 10-32 connector)	BNC (C02)	BNC (C02)
Output signal	Voltage output with CCLD compatible	Voltage output with CCLD compatible	Voltage output with CCLD compatible Applicable to TEDS (IEEE1451.4:2004) (Ver.1.0 or later)
Output impedance	100Ω or less	100Ω or less	100Ω or less
CCLD power supply	2 to 20 mA, +18 to 30 VDC	2 to 20 mA, +18 to 30 VDC	2 to 20 mA, +18 to 30 VDC
Accessories	Storage case, Extender mass*, Wax, Impact tip (vinyl), 5-44/10-32 cable (3 m), Hammer handle (aluminum, plastic), Instruction manual, Data sheet	Storage case, Extender mass, Power supply unit (sensor amplifier), Cable for hammer (BNC, 3 m), Cable for signal output (BNC, 0.9 m), Impact tip set (super soft, soft, medium, hard), Instruction manual, Data sheet	Storage case, Impact tips set (super soft, soft, medium, hard), Instruction manual, Data sheet

\*1: Extender mass should be mounted when the hammer with aluminum hammer handle is used.  
 \* NP-0021 conversion connector is required when GK-2110 is connected to BNC connector.  
 \* Signal cable is not provided as standard for the GK-4110G20.  
 \* Sensor amplifier is not provided as standard for the GK-2110 and GK-4110G20, SR-2210 2ch sensor amplifier can be used (see P.15).

#### Extension frequency characteristics

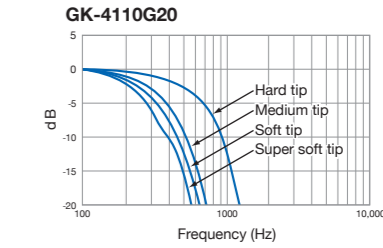
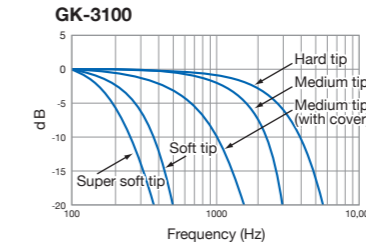
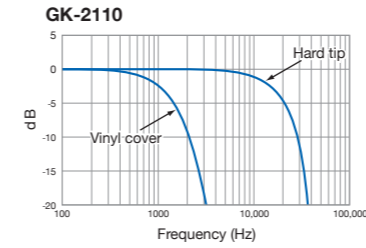

#### Option

##### Cable, connector

Product name	Model name	Applicable model
Signal cable 3m	GK-0122	GK-3100/4110G20
Signal cable 3m	GK-0132	GK-2110
Miniature/ BNC conversion adapter	NP-0021	GK-2110

##### Options for GK-2110

Product name	Model name
Vinyl impact caps (5 pieces/set)	GK-0205
Extender mass	GK-0211
Plastic hammer handle	GK-0221
Aluminum hammer handle	GK-0222

##### Options for GK-3100

Product name	Model name
Medium tip (with 5 pieces of tip cover)	GK-0503
Super soft tip	GK-0504
Soft tip	GK-0505
Hard tip	GK-0506

##### Options for GK-4110G20

Product name	Model name
Medium tip	GK-0403
Super soft tip	GK-0404
Soft tip	GK-0405
Hard tip	GK-0406

Excitation · Vibration · Analog signal processing system

# Sensor amplifier SR/PS/CH series

Ono Sokki provides wide variety of sensor amplifiers for piezoelectric acceleration sensors, including general-purpose type that emphasizes the function as a sensor amplifier, filter equipped type, battery-driven type, adapter type. You can choose according to your application.

## SR Series Sensor Amplifier

### SR-2210 2-channel Sensor Amplifier (Battery Drive)

For NP-3000/7000 series



The SR-2210 2-channel sensor amplifier can measure vibration in combination with NP-600\*/3000 series accelerometers and sound pressure level in combination with MI-3111 preamplifier (microphone: MI-1235, 1433) at the same time.

- Two input channels for simultaneous measurement of sound pressure level and vibration, or sound insulation measurement.

- Dual power source: battery or AC adapter (sold separately).

- Providing following frequency weighting: Flat, A or C (filter for measurement of sound pressure level).

- Stackable for multiple channels.

Models with \* have been already discontinued.

#### Specification

Item	SR-2210	
Input Section	Constant current power supply	Current : 2.4 mA (±20 %) Applied voltage : approx. 18 VDC
	Number of channels	2
	Operating frequency range	1 Hz to 20 kHz (±0.5 dB)*1 Load impedance 100 kΩ or more
	Input impedance	1 MΩ ±0.5 %
	Input cutoff frequency	Approx. 0.16 Hz
	Input voltage range	max. 12.5 dBVrms (±6 V)
	Gain	-10, 0, 10, 20, 30, 40, 50, 60 dB, 8 stages selectable in 10 dB steps, ±0.2 dB
	Frequency weighting	A/C/FLAT (Z) Conforming standards: IEC 61672-1: 2013, JIS C 1509-1: 2017
	Output cutoff frequency	Approx. 0.2 Hz (load impedance : 100 kΩ or more) Approx. 0.4 Hz (load impedance : 50 kΩ or more)
	Input-converted inherent noise*1	A : -105 dBVrms or less C : -100 dBVrms or less FLAT(Z) : -95 dBVrms or less
Output Section	Input / output connector	BNC (C02)
	Output voltage range	max. 12.6 dBVrms (±6 V)
General Specification	Max. output cable length	30 m or less
	Power requirement	Type AA battery cell × 4 pcs. External power supply: PB-7090 AC adapter (sold separately)
	Battery life	Approx. 20 hours or more (When 4 pcs. of type AA alkaline battery LR6 are used.)
	Operating temperature range	-10 to +50 °C
	Operating humidity range	30 to 90 % RH (with no condensation)
	Storage temperature range	-20 to +60 °C
	Storage humidity range	10 to 90% RH (with no condensation)
	Outer dimensions	140(W) × 40(H) × 125(D) mm (not including protruded section)
	Weight	Approx. 500 g (including batteries)
	Accessories	Instruction manual × 1 copy, type AA battery cell (LR6) × 4 pcs.

\*1: 1 kHz standard at FLAT (Z)

\*2: Short circuiting input, set to GAIN= 60 dB.

The value obtained by measuring the noise level of the frequency band from 1 Hz to 20 kHz, and converting input (-60 dB).

#### [Application]

- Simultaneous measurement of vibration and sound pressure of an engine

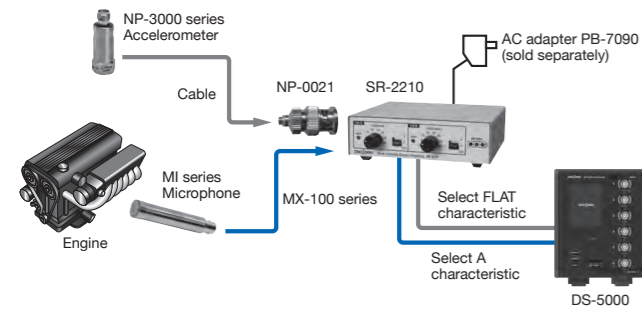

- Frequency response function measurement by impulse hammer excitation

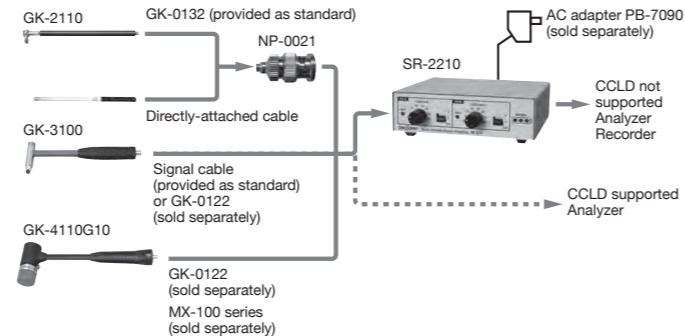

## PS Series Sensor Amplifier for Built-in Preamplifier Accelerometer

### PS-1300 3-ch Sensor Amplifier

For NP-3000/7000 series



#### Specification

Item	PS-1300
<b>Basic characteristics</b>	
Frequency response characteristics	Acceleration : 1.0 Hz to 30 kHz±0.5 dB Velocity : 3.0 Hz to 3 kHz±0.5 dB/-1.0 dB Displacement : 3.0 Hz to 500 Hz±1 dB (160 Hz=0 dB)
Accuracy	Acceleration : ±2 % Velocity : ±3 % Displacement : ±5 % (at 25 ±3 °C)
Input voltage range	±5 Vmax
Input connector	Miniature connector (Model C25 made by Tajimi Electronics Co., Ltd., or equivalent)
Input conversion noise*1	100 μVrms or less
Number of channels	3ch
CCLD power	Rated current: 2.4 mA±20 %, applied voltage: 24 VDC
Rated output voltage	AC OUT±5 Vmax
Output impedance	Approx. 50Ω
Output connector	C02 type (BNC)
Load impedance	50 kΩ or more

#### Function characteristics

Gain	1, 2, 5, 10, 20, 50, 100 (acceleration, velocity mode) 0.1, 0.2, 0.5, 1, 2, 5, 10 (displacement mode)
Filter	3rd Butterworth type filter (-18 dB/oct) HPF: Through, 3Hz, 10 Hz LPF: Through, 1 kHz, 10 kHz 10 Hz and 1 kHz: conform to vibration severity (Chebyshev type)
Connection	Multiple units can be added. Up to 3 units can be operated with SPU25A105.

#### General Specification

Power supply	10 to 15 VDC, 300 mA or less at 12 VDC IN
Operating temperature (humidity) range	-10 to +50°C (90 %RH or less, with no condensation)
Outer dimensions	See the left below
Weight	Approx. 1 kg

\*1: Short circuiting input via an inspection jig, set to GAIN=100, MOD=m/s<sup>2</sup>, HPF=Thru, and LPF=Thru.  
The value obtained by measuring the noise voltage of the frequency band from 1 Hz to 30kHz, and converting input (÷100).

#### Option

Option	Product name
-	AC adapter (for 100 to 240 VAC) SPU25A105 (PE1821078)

\*Please refer to P.17 for details.

#### Optional function

Option	Product name
PS-0131	RMS value output (0 to +5 V output)
PS-0132	Current output (4 to 20 mA output)
PS-0133	4 mA constant current drive

\*The above options can be installed simultaneously.

\*AC/DC switching is available when the PS-0131 is installed.

\*The signal output is fixed to 4 to 20 mA when the PS-0132 (current output only) is installed. 12 mA is the center of the AC output range of 4 to 20 mA.

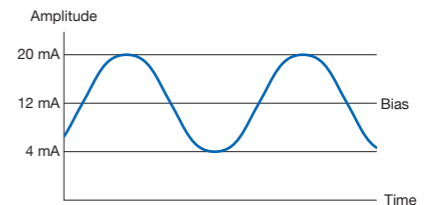

\*To separate the sensor from the amplifier by 30 m or more, installation of PS-0133 is necessary. The max. distance between the sensor and amplifier is 100 m when the PS-0133 is installed.

\*Installation fee is required to install the options after purchasing the main unit.

#### [Application]

Monitoring the motor vibration (Multiple points, distance, and transmission)

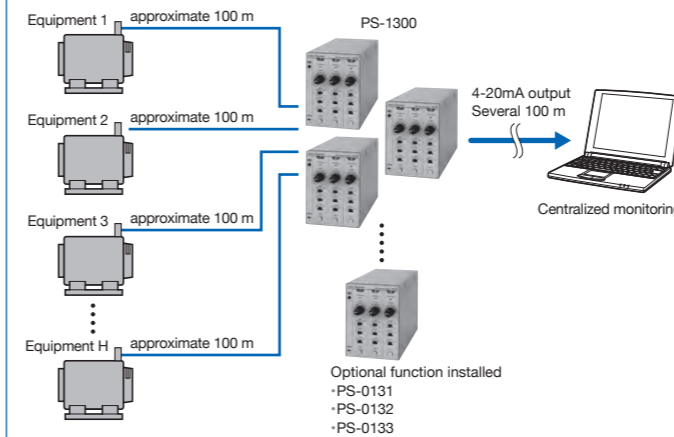

#### Outer dimensions (mm)

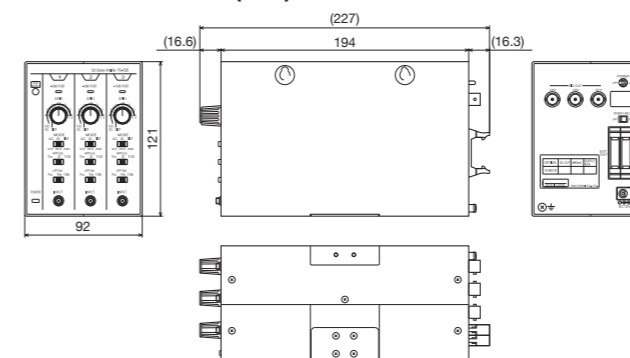

## CH Series Charge Amplifier

### CH-1200A Charge Amplifier

For the NP-2000 Series



#### Specification

Item	CH-1200A
Maximum input charge	±100,000 pC
Input connector	Miniature connector (Model C25 made by Tajimi Electronics Co., LTD, or equivalent)
Charge condenser	100 pF, 1,000 pF, 10,000 pF
Leak resistance	10 GΩ, 1 GΩ, 100 MΩ
Frequency response function	Acceleration : 1.0 Hz to 15 kHz ±0.5 dB, 0.2 Hz to 50 kHz ±3 dB Velocity : 3.0 Hz to 3 kHz ±0.5 dB Displacement : 3.0 Hz to 500 Hz ±1 dB (However, the frequency at 160 Hz to be 0 dB)
Accuracy	Acceleration : ±2 % Velocity : ±3 % Displacement : ±5 % (160 Hz at 25±3 °C)
Rated output voltage	±10 V
Maximum output load	3 mA, 1500 pF
Output connector	C02 (BNC)
Input conversion noise level <sup>*1</sup>	0.05 pC (rms) or less
Output offset	±5 mV or less
Sensitivity	0.01 to 999 pC/EU <sup>*2</sup>
Filter	HPF: Through, 3 Hz, 10 Hz (-18 dB/oct), LPF: Through, 1 kHz, 10 kHz (-18 dB/oct)
CAL signal	160 Hz ±5 %, 1 Vo-p ±2.0 %, sine wave (25 °C ±3 °C)
Maximum input alarm display function	OFF : [-10 dB/OVER] indicator blinks in red when output exceeds ±10 V. The blinks will stop when the output goes within ±10 V. ON : Blinking in red continues unless [▲/RST] switch is pushed after the output exceeds ±10 V.
Output sensitivity <sup>*3</sup>	0.01, 0.0316, 0.10, 0.316, 1.00, 3.16, 10.0, 31.6, 100, 316, 1000 mV/EU <sup>*2</sup>
Auto power save	Only the decimal point will be displayed on main display when there is no input from each switch for approx. 2 minutes or more.
Other function	Output level indicator: It turns on in green at -10 dB/F.S., blinks in red at F.S. over. Condition memory: The measurement conditions are saved even though the power is OFF.
Power requirement	10 to 15 VDC
Current consumption	120 mA or less at 12 VDC IN (When the value of 1.00 is shown at displayed device.)
Connection	Maximum 6 units can be connected for one AC adapter.
Outer dimensions	28 (W) × 121 (H) × 194 (D) mm (not including protruded section)
Weight	Approx. 510 g
Operating temperature (humidity) range	-10 to +50 °C 90 %RH or less (with no condensation)
Storage temperature (humidity) range	-10 to +60 °C 90% RH or less (with no condensation)
Accessories	Joint cable × 1 pc., stabilizer × 1 pc., connecting metal × 2 pcs., Instruction manual × 1 pc.

\*1: Short circuiting input via a reference condenser, set to RANGE=1000 mV/EU, SENS.= 1.00x 1.00 pC/EU. The value obtained by measuring the noise voltage up to 50 kHz in the frequency band, and performing input charge conversion (÷1000 x 1000 pF).

\*2: EU:Engineering unit

\*3: Output sensitivity; Output power per 1EU  
Note: The output polarity is turned over.

#### Options

Model	Product name
-	AC adapter (for 100 to 240 VAC) SPU25A105 (PE1821078)

CH-1200A is a charge amplifier which is used in combination with NP-2000 series charge output accelerometers. It is fully-featured performance and functionality necessary for vibration measurement such as high-pass filter, low-pass filter, CAL signal output and setting of output sensitivity in 10 dB steps.

- Compact and cost-effective amplifier focused on vibration and acceleration measurements.
- Can be used with charge output accelerometers.
- Output sensitivity range can be set at each 10 dB steps. It is suitable for an output to data recorder and so on.
- Low-pass and high-pass filters are incorporated to get rid of unwanted noise.
- Oscillator for calibration is built in a main body.
- It works with 12 VDC power supply. AC adapter and battery unit are available as options.
- Integral function is provided. It measures acceleration and displacement (can be changed at each channel).

### SPU25A105 AC adapter

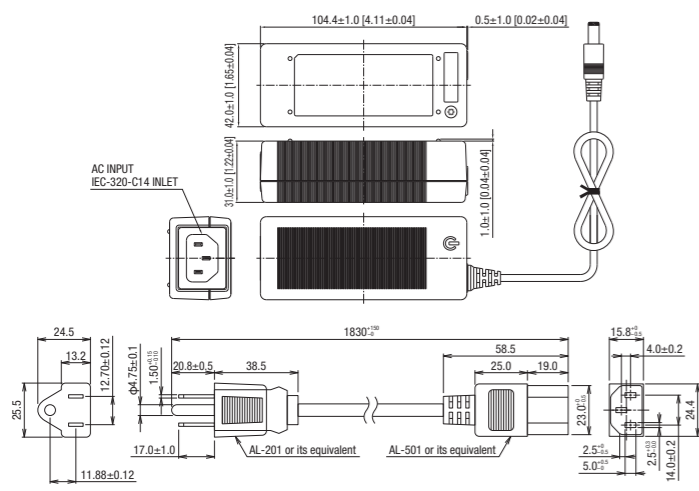

#### Specification

Outer dimensions	: 42(W) × 104.9(D) × 31(H) mm
Weight	: Approx. 170 g (not including AC cable)
Input voltage	: 90 to 264 VAC
Rated output voltage, current, polarity	: 12 VDC, 2 A, outside+
Operating temperature range	: 0 to +70 °C (with no condensation)

### CH-1200A System Configuration

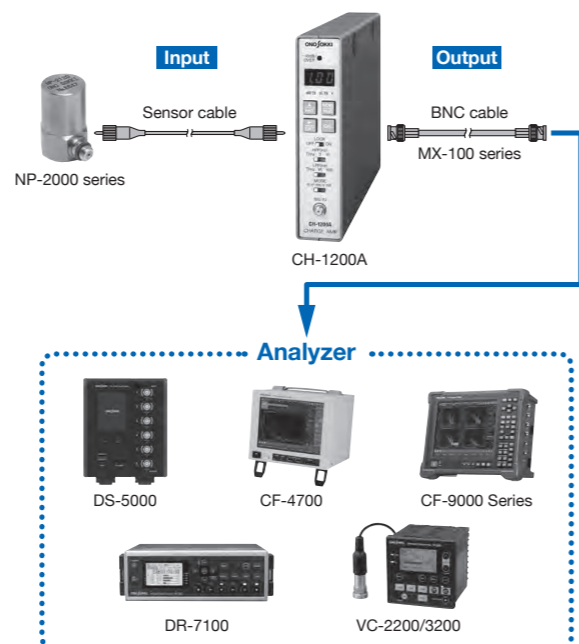

## CH Series Charge Converter

### CH-6130/6140 Charge Converter (Adapter Type)

For NP-2000 series



The CH-6130/6140 models are simple charge amplifiers that can convert charge signals into voltage signals. By using this charge converter, charge output type accelerometers can connect directly to CCLD type measuring instruments such as VC-2200/3200 vibration comparators, CF series and DS series FFT analyzers, without separate use of charge amplifier.

- Compact, lightweight, simple charge amplifiers.
- Can be easily connected to VC-2200/3200, DS-2000/3000/5000 series (BNC connector).
- Charge output accelerometers can be connected directly to measuring instruments (those that can accept input from a constant current line drive) without need for a separate charge amplifier.
- There are two models available, the CH-6130 with a conversion coefficient of 1 mV/pC (converts a 1-pC charge signal to a 1-mV voltage signal), and the CH-6140 with a conversion coefficient of 10 mV/pC. Make your selection according to the sensitivity of the input sensor.

#### Specification

Item	CH-6130	CH-6140
Gain	1.0 mV/pC <sup>*1</sup>	10 mV/pC <sup>*1</sup>
Frequency range	5 Hz to 15 kHz (±0.5 dB) <sup>*2</sup> , 2 Hz to 45 kHz (±3 dB) <sup>*2</sup>	
Maximum output voltage	10 Vp-p or more	
Output bias	10 ±2 VDC	
Input conversion noise	0.05 pC (rms) or less	
CCLD power supply	Voltage: 18 to 36 VDC, constant current: 2.0 to 20 mA	
Connector configuration	Input: Miniature connector, No. 10-32UNF screw Output: C02 plug (BNC plug)	

\*1: At 160 Hz  
\*2: When the gain is 0 dB at 160 Hz.  
Note: The output polarity is turned over.

### CH-6130/6140 connection diagram

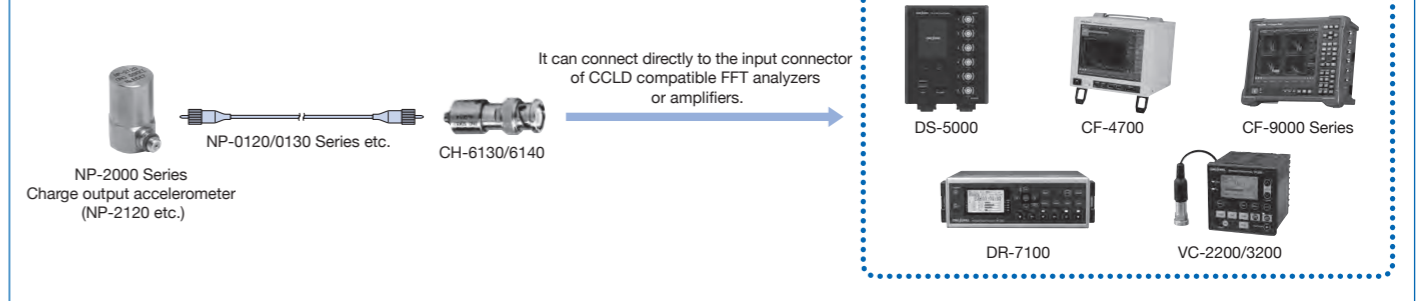

### The Difference between CH-1200A and CH-6130

The charge output accelerometer generates electric charge according to detected vibration. In order to connect a charge output type accelerometer to a voltage input type analyzer (FFT analyzer, logger), it is necessary to convert the charge generated into voltage by using the charge amplifier to a voltage. The following is an explanation of the distinction between CH-1200A and CH-6130.

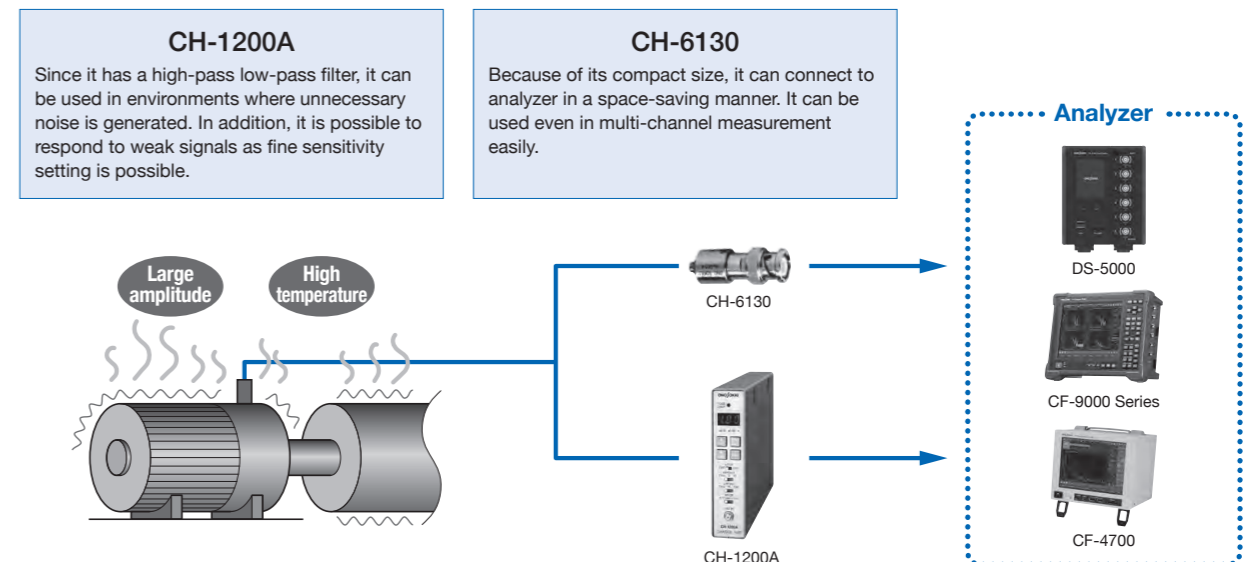

#### CH-1200A

Since it has a high-pass low-pass filter, it can be used in environments where unnecessary noise is generated. In addition, it is possible to respond to weak signals as fine sensitivity setting is possible.

#### CH-6130

Because of its compact size, it can connect to analyzer in a space-saving manner. It can be used even in multi-channel measurement easily.

Calibration

VX-1100A Sensitivity Calibrator for Piezoelectric Accelerometer (Battery Drive type)



Piezoelectric accelerometers are widely used in vibration measurements. In order to obtain correct data, it is necessary to check the operation (sensitivity) of sensor before use. The VX-1100A is a simple type sensitivity calibrator that is designed for use with piezoelectric accelerometers. This calibrator has functions as excitor, sensor amplifier, and display unit so the sensitivity value can be read directly on the display simply by connecting an accelerometer to the VX-1100A. The VX-1100A excites an accelerometer with sine wave of 159.2 Hz and 10 m/s<sup>2</sup> (rms) so that the output can be used as calibration signal for vibration measurement system.

- The excitor, sensor amplifier and display functions all have been integrated into one device for user convenience.
- Suitable for accelerometer of both charge output and built-in amplifier types. Required amplifier can be selected by switch. (2.0 mA, 4.0 mA, Charge amplifier)
- Sensitivity value can be read directly on the built-in digital display unit.
- Long-term continuous operation is enabled (approx. 8 hours).
- Compact and light-weighted.
- A carrying case is provided as standard to make carrying easy.
- Basic accessories necessary to measure are provided as standard.

■ Specification

Excitation frequency:	159.2 Hz ± 1 %
Excitation acceleration:	10 m/s <sup>2</sup> (rms) ± 3 %
Excitation velocity:	10 mm/s (rms) ± 4 %
Excitation displacement:	10 μm (rms) ± 5 %
Harmonic distortion:	3 % or less
Sensitivity display range:	0.01 to 19.99 mV/(m/s <sup>2</sup> ) 0.01 to 19.99 pC/(m/s <sup>2</sup> )
Sensitivity display accuracy:	±3% ±1 digit

- Compatible accelerometer weight:  
110 g or less
- Sensor power supply:  
constant current: 2.0 mA or 4.0 mA switching voltage: 24 VDC
- Power requirement:  
Type AA battery cell × 4 pcs.
- Battery life:  
Approx. 8 hours (when detector weight is approx. 25 g, driving current is 2.0 mA, alkaline batteries are used.)
- Operating temperature range:  
+10 to +40 °C
- Operating humidity range:  
90 % RH or less (with no condensation)
- Weight:  
Approx. 1 kg
- Outer dimensions:  
120 (W) × 140 (D) × 50 (H) mm (not including protruded section)
- Accessories:  
Signal cable (50 cm length, C02 BNC-Miniature connector)  
Conversion screws (M5-M3, M5-M6, M5-No.10-32UNF)  
Flat table (M5-flat)  
Type AA battery cell × 4 pcs.  
Hard carrying case,  
Instruction manual

★ Depending on the model of sensor used, a BNC/Miniature conversion adapter (NP-0021) may be required. Please contact your sales representative for details.  
Note: The VX-1100A cannot be used for NP-2106 and 2506.

Application 1

Input signal from the sensor directly and check the sensitivity.

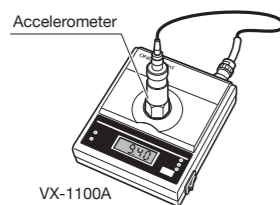

Application 2

Use only the exciter to calibrate the vibration measurement system.

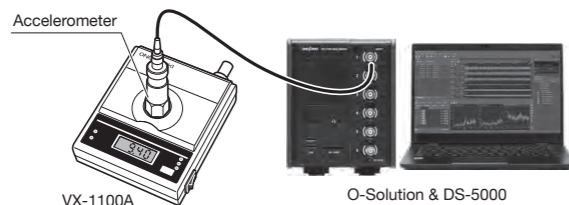

Outer dimensions (mm)

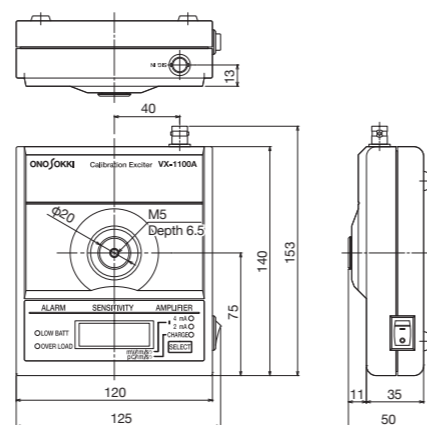

Outer dimensions

GK-2110

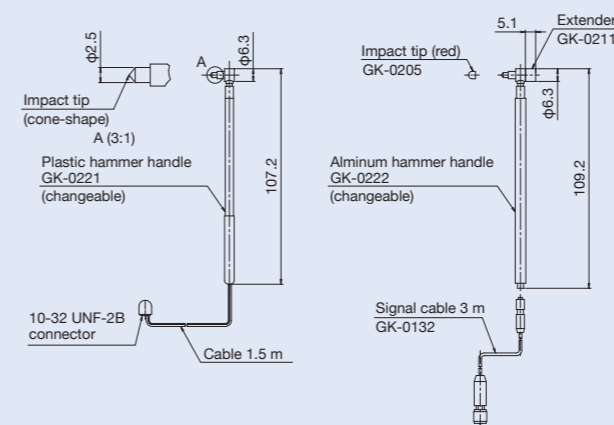

GK-3100

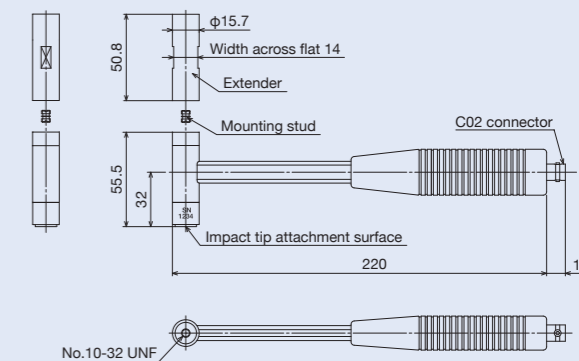

GK-4110G20

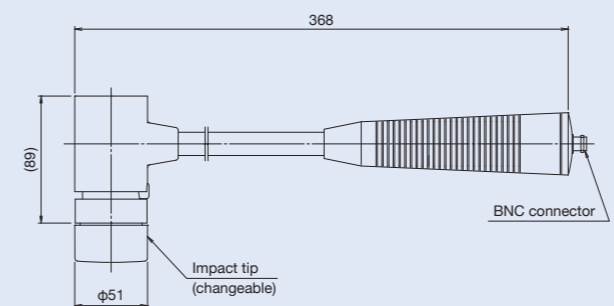

SR-2210

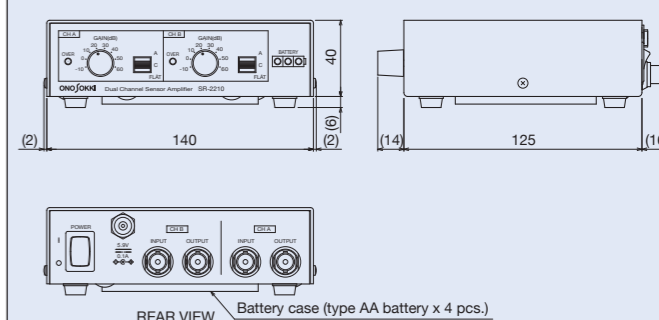

CH-1200A

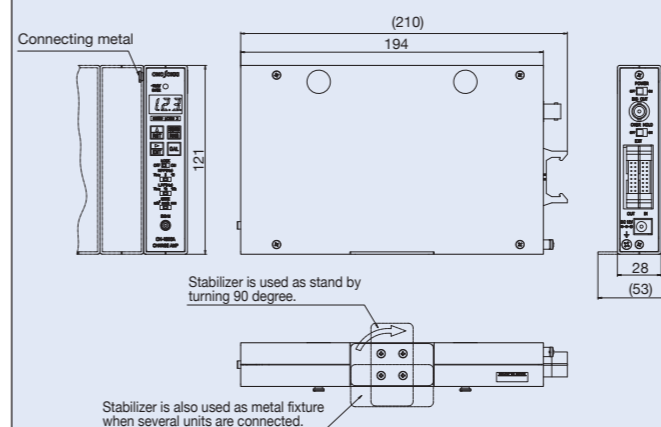

CH-6130/6140

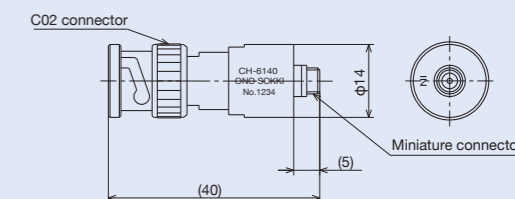

Reliable and high-level calibration JCSS Accredited Calibration Laboratory

Ono Sokki provides reliable and high-level calibration as "Accredited Calibration Laboratory", which is certified by JCSS\* calibration laboratory accreditation system, base on the skills and know-how of quality assurance system which has been acquired through many years of practice. Under the calibration laboratory accreditation system of JCSS, Ono Sokki is assessed and accredited as Accredited Calibration Laboratories to meet the requirements of the Measurement Law, relevant regulations and ISO/IEC.

Accreditation Scope

- Acoustic & Ultrasound (2005. 12)
- Acceleration (2012. 12)
- Torque (2013. 5 : 50 to 5000 N•m, 2018.10 : 1 to 50 N•m)
- Fluid flow (2014. 11)
- Electricity (2015. 6)
- (Direct Current & Low Frequency)
- Speed (2019. 3)
- Time & Frequency & Rotational speed (2020.12)

\*JCSS: Japan Calibration Service System

Ono Sokki can issue the calibration certificates with the JCSS accreditation symbol, which assures the traceability to National Measurement Standards as well as a laboratory's technical and operational competence, and is acceptable in the world through the ilac-MRA.



(Unit: mm)



**WORLDWIDE ONO SOKKI CO., LTD.**

3-9-3 Shin-Yokohama, Kohoku-ku, Yokohama, 222-8507, Japan  
Phone : +81-45-476-9725 Fax : +81-45-476-9726  
E-mail : overseas@onosokki.co.jp

\* Outer appearance and specifications are subject to change without prior notice.

URL: <http://www.onosokki.co.jp/English/english.htm>

**U.S.A.**

Ono Sokki Technology Inc.  
2171 Executive Drive, Suite 400,  
Addison, IL. 60101, U.S.A.  
Phone : +1-630-627-9700  
Fax : +1-630-627-0004  
E-mail : info@onosokki.net  
<http://www.onosokki.net>

**THAILAND**

Ono Sokki (Thailand) Co., Ltd.  
1/293-4 Moo.9 T.Bangphud  
A.Pakkred,  
Nonthaburi 11120, Thailand  
Phone : +66-2-584-6735  
Fax : +66-2-584-6740  
E-mail : sales@onosokki.co.th

**INDIA**

Ono Sokki India Private Ltd.  
Plot No.20, Ground Floor, Sector-3,  
IMT Manesar Gurgaon-122050,  
Haryana, INDIA  
Phone : +91-124-421-1807  
Fax : +91-124-421-1809  
E-mail : osid@onosokki.co.in

**P.R.CHINA**

Ono Sokki Shanghai Technology Co., Ltd.  
Room 506, No.47 Zhengyi Road, Yangpu  
District, Shanghai, 200433, P.R.C.  
Phone : +86-21-6503-2656  
Fax : +86-21-6506-0327  
E-mail : admin@shonosokki.com