

CF-9000A series

ONOSOKKI

Portable 2-channel / 4-channel

# FFT Analyzer

Innovative features in a tough body



**The right tool for quickly making decisions and taking action.  
A reliable partner that accepts no compromise.**

Portable FFT analyzers

# CF-9200A    CF-9400A

[For 2-channel analysis]

[For 4-channel analysis]



The CF-9200A/CF-9400A is an all-in-one portable FFT analyzer. All FFT analysis operations can be performed with the integrated hard keys and capacitance type touch panel without requiring a PC.

Newly developed exclusive 100 kHz high-performance analysis front-end system incorporating 24-bit A/D converter analyzes sound and vibration of a piping/pump in a factory plant, motor, automobile, railway vehicle, mechanical instruments including home electrical appliances, and electrical /electronic parts.

The CF-9200A/9400A helps to find solutions for field workers in their FFT analysis including the resonance and frequency characteristics of mechanical structures by using an electromagnetic exciter or an impulse hammer.

## Speedy

### Keys and a touch panel for quick, light and intuitive operation

With the CF-9200A/9400A, basic FFT analysis operations such as display, measurement, stopping, recording and readout can be made positively and quickly through the large hard keys. The touch panel provides an intuitive interface, allowing the operator to easily perform speedy and reliable operations by a swipe or tap with fingers on the screen, such as selecting the number of waveforms displayed and scaling of the X and Y axes to the desired scale.



## Flexible

### 8 hours\*1 of continuous cordless operation. Replacement of batteries while powered on

The CF-9200A/9400A includes the two on-board, large capacity lithium ion secondary batteries which enable continuous cordless operation of 8 hours\*1. The hot swap feature which allows battery replacement while it is power-on enables continuous measurement operation of analysis and recording without interruption. The built-in battery in the main unit can also be charged while in operation.\*2

\*1 CF-9400A 4ch, when CCLD is ON.  
\*2 Full recharge takes 7 or 8 hours depending on operating conditions.



## Versatile

### FFT, RTA, excitation control & simultaneous recording

The CF-9000A series are compact and versatile to carry out various operations including linear/log, sweep analysis using signal output, amplitude control of electromagnetic exciter\*3, as well as FFT Analysis, real-time octave analysis\*1, and rotation tracking analysis\*2.

It can also perform simultaneous analysis and recording operations, allowing offline analysis by CF-9200A/9400A main unit and software applications\*4.

\*1 Real-time Octave Analysis (RTA) (CF-0923) is required.  
\*2 Tracking Analysis (CF-0922) is required.  
\*3 Log Sweep/Excitation Control (CF-0942) is required.  
\*4 Please refer to P.10, 11 for details.

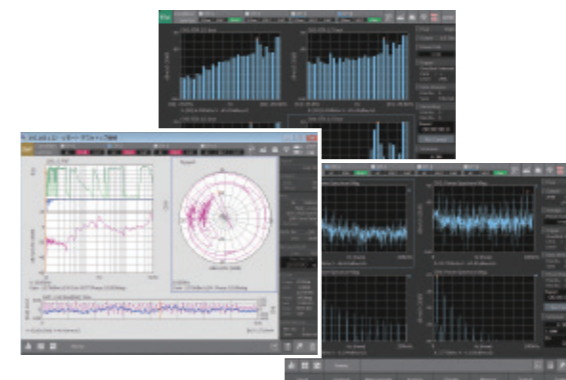

## Quiet

### Silent and non-vibration by fan-less & spindle-less structure

Fan-less and spindle-less structure prevents occurrence of mechanical sound and vibration. The CF-9200A/9400A itself does not become the cause of sound and vibration, and not disturb measurement and recording in a field. By installing wireless LAN adapter, you can operate remotely\* without touching the main body of the CF-9200A/9400A.

\*When Microsoft® Remote Desktop is used.

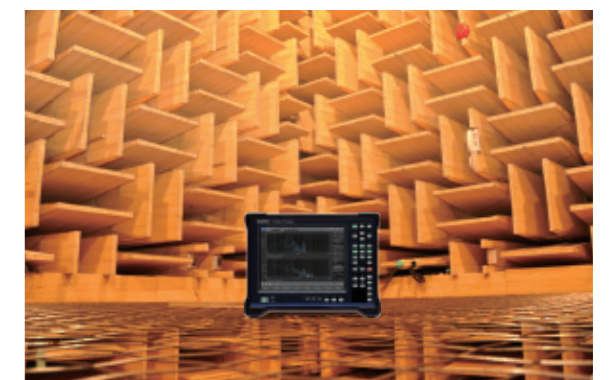

# Dynamic and Steady

## Various function designed through accumulated technology on CF-9200A/9400A

### Real-time tripartite graph display / Vibration criterion curves

The CF-9200A/9400A is equipped with real-time tripartite graph\*1 display as a new standard function. Three amplitude values (acceleration (m/s<sup>2</sup>), velocity (m/s) and displacement (m)) at any arbitrary frequency can be read simultaneously in real time during FFT analysis of vibration. By processing 1/3 octave and displaying VC curves\*2 (Vibration Criterion Curves), allowable vibration reference or setting environment evaluation of vibration sensitive instrument, such as AFM, electronic microscope, and Laser interferometer is able to be judged quickly. You do not need to operate differential and integral processing individually by using the frequency analysis function and conversion of amplitude values as before. Therefore, this function enables you to read three amplitude values quickly.

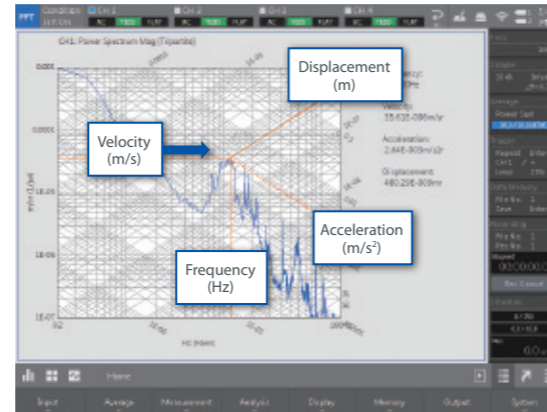

\*1 The tripartite graph (diagram) enables you to read amplitude values of acceleration (m/s<sup>2</sup>) and displacement (m) which is based on velocity (m/s), on the frequency (Hz) axis.  
\*2 VC curves are proposed as a guide of allowable small vibration for setting precise machinery. Evaluation in 1/3 octave band width when VC Curve is used. It is divided in total 5 stages at an interval of 6 dB (VC-A, VC-B, VC-C, VC-D and VC-E) by the aim of usage for various instruments such as light microscope or laser equipment with long light path.

### Easy operation through a touch panel interface

The CF-9200A/9400A employs a 10.4 LCD capacitance type touch panel, allowing the operator to tap and swipe graphs. The band or gain which you have selected can be widened or narrowed with a simple and intuitive action. Only a simple gesture (finger movement) operation is needed to perform the following functions; fitting waveform amplitude to the graph scale, changing positions of waveform graphs, scaling of time axis and frequency axis, offsetting of waveform, and graph span adjustment.



### Reliable inputs with large hard keys

Operations such as turning the power on and off, changing data types and saving data are carried out using the new large hard keys. An excellent operational feeling of these keys assists fast and correct input even in unstable or narrow space and prevents data missing or malfunction. Lock function (HOLD) for hard keys and touch panel are equipped in order to prevent unintended inputs and setting changes.



Channel and waveform selection (CF-9400A) Basic operations

### Wide dynamic range

The CF-9200A/9400A features a new 24-bit A/D front-end system, offering more than 120 dB wide dynamic range. Changing voltage range due to A/D over is not required by this function anymore, which had been frequently performed in general acoustic or vibration measurement. Wide dynamic range allows more efficient measurement and data recording, easier to operate even for novices.

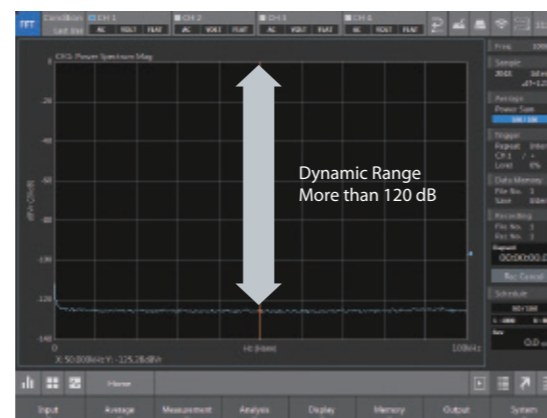

### Highly visible LED indicators

Statuses of major FFT operations are shown by LED indicators. The hard keys for major functions also have LED indicators. This enables the operator to monitor operating state of FFT, such as the power-up process, the charging state of the secondary batteries, and the excessive input to an A/D converter even from a distance.



### All signal input channels isolated

All signal input channels are isolated (insulated). With high resistance to ground loops and super imposed noise, the main unit offers highly reliable measuring performance even in locations which is prone to potential difference. The isolation scheme also protects the crucial areas of the FFT system from sensors or signals that can be exposed to harmful transient voltages.



CF-9200A CF-9400A

### Cable disconnection detecting function

When cable disconnection detecting function is on, the CF-9200A/9400A automatically detects cable disconnection or connector trouble of an accelerometer and a microphone\*, preventing trouble before measurement.

\* Microphone with a built-in constant current line drive (CCLD) type preamplifier.

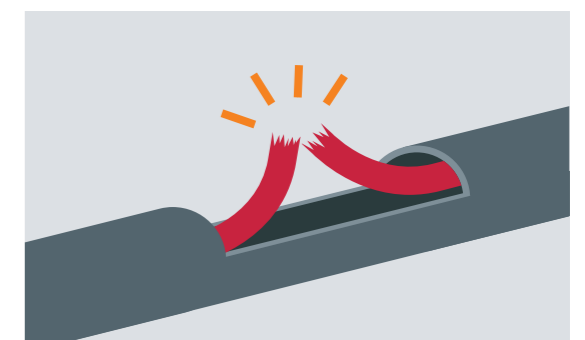

### Equipped with CCLD\*1, applicable to TEDS\*2

Each channel of the CF-9200A/9400A is equipped with CCLD (power supply for sensors) which can directly drive an accelerometer with built-in preamplifier, a charge converter for charge output type accelerometer, and a measurement microphone. TEDS reads data retained in a TEDS sensor and allows supplying the power to the sensor and performing the unit calibration automatically.

\*1 What is CCLD (Constant Current Line Drive)?

It means a sensor interface using constant current supply. CCLD for an accelerometer with built-in preamplifier or a microphone preamplifier enables direct connection to an FFT Analyzer without using external amplifier. 2 to 4 mA of CCLD is commonly used.

\*2 What is TEDS (Transducer Electronic Data Sheet)?

It is a standardized method which describes the information relevant to a measurement sensor. It is defined in the IEEE 1451 series. As information of a TEDS sensor is automatically read to the TEDS available measurement devices, the user is ready to take measurements. It can avoid setting error and also saves you time and effort of troubling calibration and measurement preparation.

# From the laboratory to the field, real-time waveform measurement / analysis and simultaneous waveform recording are achieved with just one unit.

## CF-9200A/9400A

### FFT Basic Analysis Functions

#### Time-axis Waveform

Performs A/D conversion of the voltage signal of vibration, noise, distortion, current probe, etc. coming from a sensor and displays the result as time-domain data. The X and Y-axis values at any point can directly be read using the search cursor. The delta cursor function makes it easier to read the time difference and level difference. The time-axis data statistical processing function enables quantitative time waveform analysis and diagnosis of such items as mean value (MEAN), root mean squared value (RMS) and crest factor.



#### Power Spectrum

The power spectrum shows the magnitude of each frequency component included in the time-axis waveform, which has been obtained with the FFT Analyzer, in the form of graph with the frequency on the horizontal axis by calculating the power of each frequency band (frequency resolution  $\Delta f$ ). Power spectrum analysis enables detection of abnormal conditions of a facility, which are difficult to be estimated through measurement of vibration, noise level, and observation of time waveform. The natural frequency of a structure can also be measured.

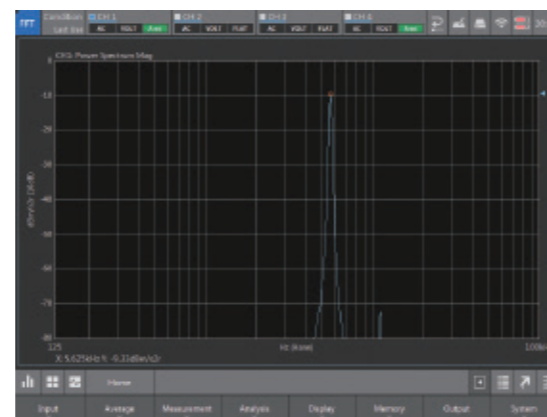

#### Frequency Response Function

The frequency response function (FRF), in a mechanical system or an electrical circuit system, shows the input-to-output ratio as gain and phase characteristics on the axis representing frequency. The gain characteristics indicate how the amplitude of input signals changes as they pass through the transfer system being evaluated. The ratio of the output amplitude to the input amplitude is plotted on the Y-axis. The phase characteristics indicate phase advance/delay between the input and output signals with the Y-axis plotted in degrees or radians.

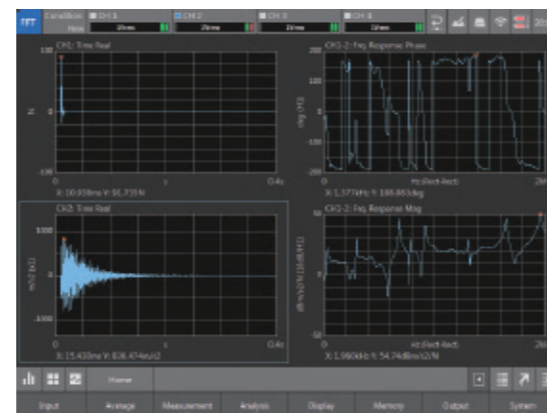

## CF-9200A/9400A

### Optional Software for Analysis

#### Tracking Analysis (CF-0922)

CF-0922 Tracking analysis function automatically stores FFT values during calculating the vibration or noise which has occurred when rotating with wide variation speed, and analyzes the physical phenomena with reference to the rotation speed, such as vibration and noise changing with speed. Since machines (rotary machine) turning at their axes including an engine, a gearbox turbine, and a motor turn in wide range of rotation speed from low to high, they may produce large vibration and noise by the resonance of component parts at specific rotation speed. To reduce the risk of destruction and to increase quietness, it is necessary to evaluate the relationship of natural vibration frequency between rotation speed and component parts. By using the CF-0922 Tracking Analysis software, you can see and analyze the relationship between rotation speed and physical phenomena at specific rotation speed range in various expressions such as color map, 3D graph, and order components on the basis of one rotation.

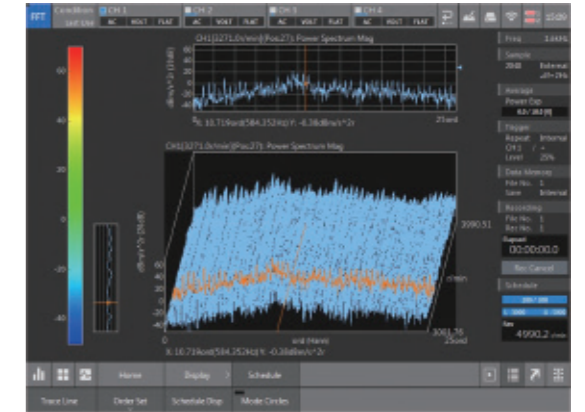

#### Real-time Octave Analysis (RTA) (CF-0923)

The highest note of an octave has twice the frequency of the octave's lowest note. As the feeling of human hearing has characteristics in equal ratio to frequencies, the Real-time Octave Analysis (RTA) software (CF-0923) is an effective tool for noise analysis. The sound pressure level of every band can be obtained through band-pass filter which is defined by standard of 1/1 or 1/3 octave in the noise frequency range to be measured.

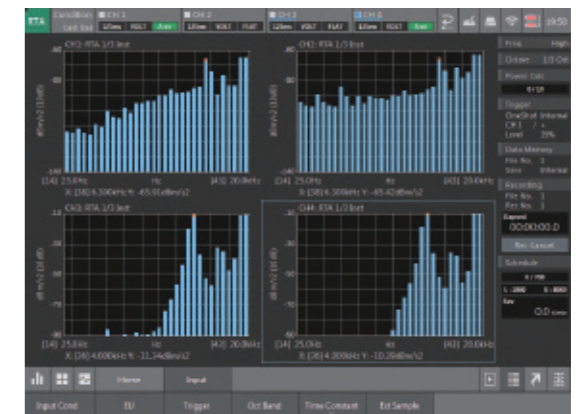

#### Log Sweep / Vibration Control (CF-0942)

The Log Sweep function is used to evaluate the resonance points of a transfer system by continuously changing the frequency of the driving sine waves from the 1ch Signal Output Module (CF-0971). By sine-sweeping the frequency axis with a logarithmic scale, it is possible to obtain the gain and phase for each single frequency and an accurate response function with a high S/N ratio. The Excitation Control limits the amplitude of an electromagnetic exciter to a desired range, enabling vibration testing without considering the frequency characteristics of the exciter.

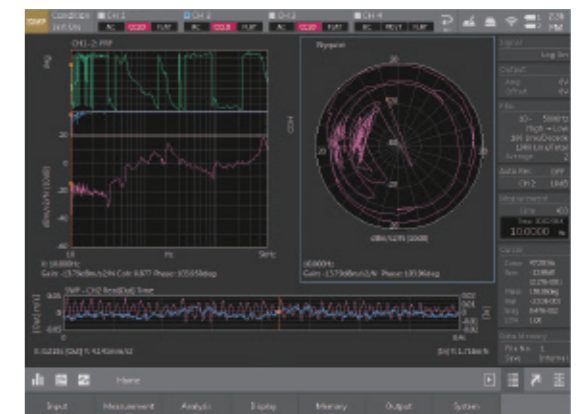
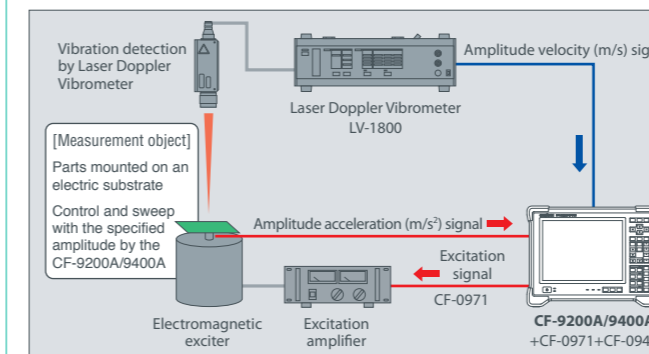

\* 1 ch Signal Output Module (CF-0971) is required for this software.

# System Configurations

From detection to processing, analysis, and graph creation. The CF-9200A/9400A is supported by a wide range of peripherals including sensors for excitation, sound, vibration and rotation.

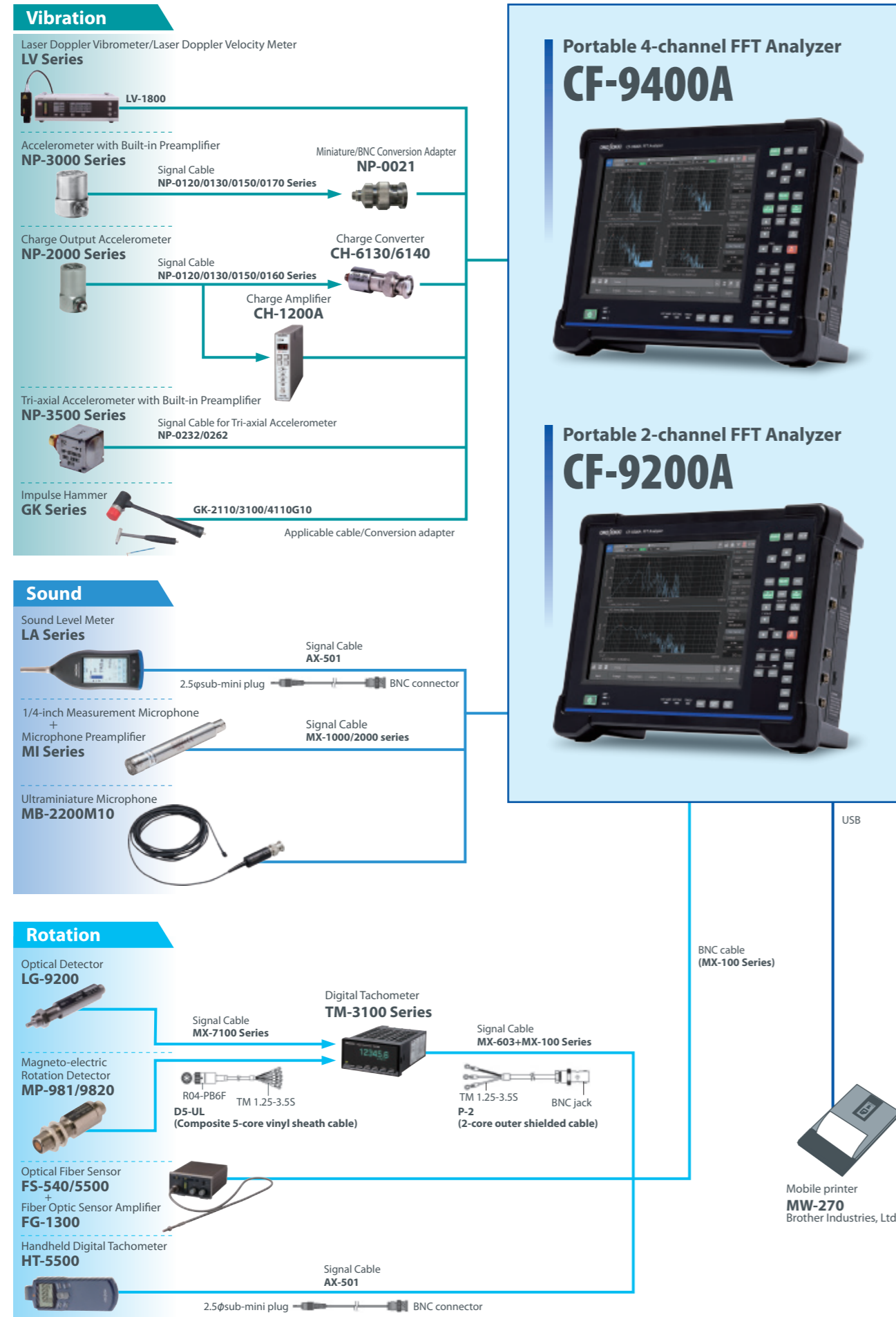

# Memories & Data Sharing

The CF-9200A/9400A has wide variety of memory mediums and interfaces including wire/wireless, such as SSD (Solid State Drive) and SD/SDHC/SDXC memory card. You can choose a suitable one according to the field or office environment.

## MEMORIES

### SSD (Built-in CF-9200A/9400A)

SSD built-in the 9200A/9400A can record and read waveforms, analysis data, waveform image, setting condition, and digital recording data. An SSD is less affected from noise and vibration because this medium does not have drive section which produces noise and vibration.

### SD/SDHC/SDXC Memory Card

The CF-9200A/9400A has a memory card slot(×1) for SD/SDHC/SDXC. Waveforms, analysis data, waveform images, setting conditions, and digital recording data can be recorded and read via an SD/SDHC/SDXC memory card. Data which was recorded in a built-in SSD is copied and transferred easily into an SD card or a USB memory card.

### USB memory

The CF-9200A/9400A has USB connectors (×3). Waveforms, analysis data, waveform images, setting conditions, and digital recording data can be recorded and read via a USB memory. Data transfer and copy of data which has been stored in a built-in SSD are easy, such as data transfer/copy to a USB memory.

\* Not all types of USB memory are guaranteed for the operation. Encrypted USB memory cannot be used.

## DATA SHARING

### Folder sharing on LAN function **Standard**

FFT measurement data and record data (ORF) saved in the CF-9200A/9400A built-in SSD can be accessed directly from a Windows® PC. Data extraction and graphing with dedicated software can be performed smoothly. In addition, the data saved on the main unit of CF series can be easily copied and saved on the PC.

PC environment conditions for connection  
Windows® 10 (32 bit, 64 bit)

### LAN Connection function **Partly Option**

Connecting the CF-9200A/9400A to Windows®-based PC with LAN cable provides various operations as below.

- Copying and saving measurement data
- Operation remotely from a PC side using Remote Desktop Function\*1
- Projecting the screen of the CF-9200A/9400A by a projector
- Controlling the CF-9200A/9400A by program (CF-0947: LAN external control function (option) is required.)

PC environment conditions for connection  
Windows® 10 (32 bit, 64 bit)



### Wireless LAN connection function **Option**

Mounting wireless LAN adapter\*2 allows remote control\*1 of the CF-9200A/9400A including screen display etc. by Windows®-based PC or mobile information terminal.



### Bluetooth® connection function **Option**

Mounting Bluetooth® receiver\*2 enables wireless output of graph displaying screen to a mobile printer\*2 by PRINT button operation. A keyboard can also be connected wirelessly.



\*1 Microsoft® Remote Desktop is used. \*2 Please use the recommended product by Ono Sokki.

# CF-9200A/9400A × O Series

O series software is useful for secondary processing for the data recorded by the CF-9200A/9400A. By import and browse of the data, O series software helps smooth data organization, processing, analysis and graph creation.

# High performance software supports various analysis

CF-9200A/9400A record simply, analyze smoothly.



## OC-1300 Series Toolbox

The OC-1300 Toolbox software system supports organization and graph creation of the data which has been obtained by FFT Analyzer. Two kinds of software tool support visualization of the obtained data.

### CF-9200A/9400A Data file corresponding

#### DAT Browser

Time domain waveform, power spectrum, bundled octave, Fourier spectrum (Real, Imag, Mag, Phase), frequency response function (Real, Imag, Mag, Phase), coherence, tracking, RTA (1/1, 1/3)

#### TRC Browser

Constant width (time, revolution), constant ratio (time, revolution), RTA (1/1, 1/3 (time, revolution))

### DAT Browser OC-0340

DAT Browser can collectively read more than 100 of FFT data (DAT) which have been stored in the CF-9200A/9400A or a PC, and create graph. It also allows data selection, differential and integral calculi, overdrawing, output to the OC-1300 series, image output as BMP or metafile format.

- Graph creation of stored data up to 100 at once

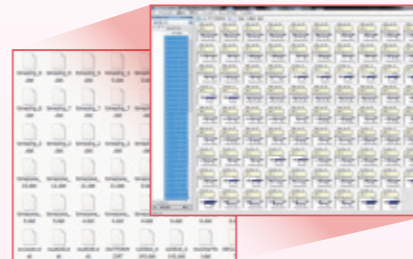

- Example of overlapping graph. Order lines can also be overlapped.



### TRC Browser OC-0341

TRC Browser is software to create graphs from the tracking data stored in the CF-9200A/9400A or a PC. TRC Browser can import multiple tracking data files and create graphs with multiple windows.

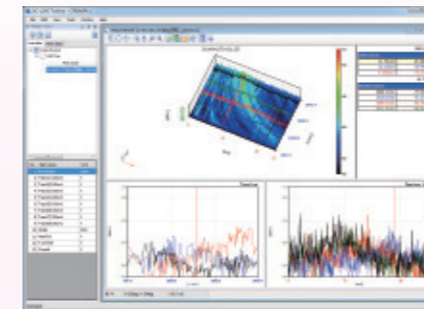

Model name	Product name
OC-1340	DAT・TRC Browser package*1
OC-0320	Digital map*2
OC-0330	Cube controller*2
OC-0340	DAT Browser*2
OC-0341	TRC Browser*2

\*1 OC-1340 includes OC-0340 and OC-0341.  
\*2 OC-0320, 0330, 0340, 0341 are able to be used singly.

EXPORT

## OC-1300 Series

Graph Creation Tool



The OC-1300 series is software that anyone can make a beautiful graph easily, quickly, and smoothly. You can design a graph layout freely by dragging the axis with a mouse. A complicated multi-axis graph that is difficult to be created by spread sheet software is able to be created easily.

Graphs which have been created in the OC-1300 Toolbox or the O-Solution are easily exported to the OC-1300 series by one-click operation. You can create a visually appealing graph by writing marker value in the waveform and pasting a photo image on the graph.

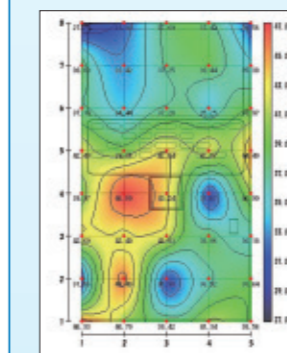
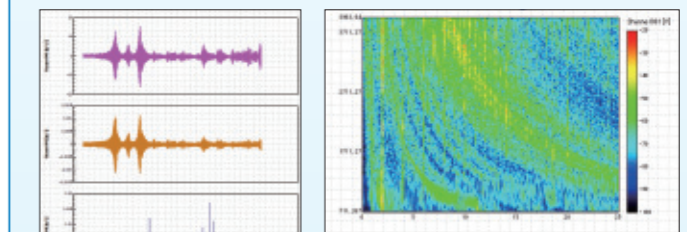
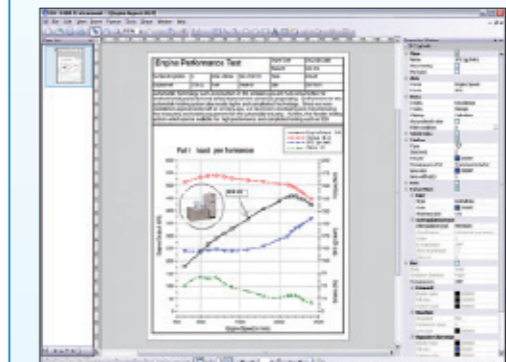

Sound pressure which is emitted from the machines is expressed smoothly in a contour map by the OC-1300 series.

For further analysis, you can acquire concrete image of the result by superposing a contour map with the exported photo image etc. Specifying the transparency of the contour map allows you to see them clearly.

## O-Solution

Sound and Vibration Analysis system

The O-Solution is the software that allows you to freely edit, process and analyze various data recorded by the CF-9200A/9400A. It enables advanced data processing and analysis such as calculus processing of recorded time-series data, playback of recorded sounds, filter processing, fluctuation sound analysis, etc. In addition, "Simultaneously displaying, Displaying side-by-side, Overlapping" of the data with different physical quantities (vibration, rotational speed, torque, temperature, etc.), formats and sampling frequencies.

### Basic/option functions

Model name	Product name
OS-5100	Platform
OS-0521	Digital Filter Function
OS-0522	FFT Analysis Function
OS-0523	Tracking Analysis Function
OS-0524	Octave Analysis Function
OS-0525	Sound Quality Evaluation Function
OS-0526	Fluctuation Sound Analysis Function
OS-0527	Time Frequency Analysis Function
OS-0531	Statistical Analysis Function
OS-0512	Hardware Connecting Function
OS-0510	External Control Function

- Main window



- FFT Analysis Function: OS-0522

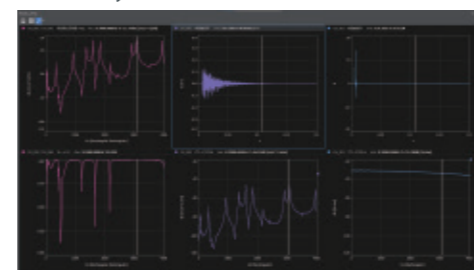

- Digital Filter Function: OS-0521



- Fluctuation Sound Analysis Function: OS-0526

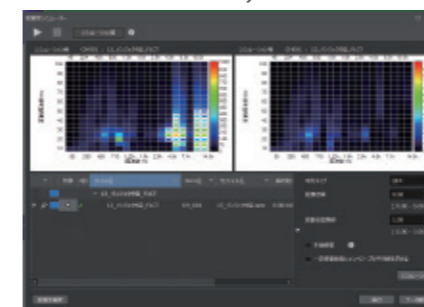

### OC-1300 series Product list

Model name	Product name
OC-1310	Basic
OC-1320	Standard
OC-1330	Professional
OC-0310	Control API

**1. Input Section**

Number of input channels	2 (CF-9200A), 4 (CF-9400A)	
Input connector	BNC (CO2 type)	
Input configuration	Single-ended	
Isolation	Isolated between each channel (permanently)	
Input impedance	1 MΩ±0.5 %, 100 pF or less	
Input coupling	DC or AC (0.5 Hz, -3 dB±10 %)	
Power supply for sensor (CCLD)	+24V/4 mA	
Cable disconnection detecting function	Automatically detects cable disconnection when using CCLD	
TEDS function	IEEE1451.4 Ver.0.9/1.0 accelerometer, microphone IEEE1451.4 Ver.1.0 force sensors	
Absolute maximum input voltage	70 Vrms AC for 1 minute (50 Hz)	
Input voltage range	1 Vrms, 31.62 Vrms (2 ranges)	
DC offset	-60 dB F.S. or less (When auto zero is on.)	
Input level monitor	Lights up in red LED at excessive input. (Lights up in red for a range F.S.)	
Frequency range	DC, up to 100 kHz	
A/D converter	24 bits type ΔΣ	
Dynamic range	120 dB or more (at FFT frame length 4096 points or more at 1 kHz or more)	
Amplitude flatness	Less than 20 kHz	±0.1 dB
	20 kHz or more	±0.2 dB
Harmonic distortion	Less than 20 kHz	-80 dB
	20 kHz or more	-75 dB
Aliasing	-80 dB or less	
Full-scale accuracy	±0.1 dB (at 1 kHz)	
Amplitude linearity	±0.0015 % (at full scale)	
Channel to channel cross-talk	-100 dB or less (at 1 kHz)	
Channel to channel gain accuracy	Less than 20 kHz	±0.05 dB
	20 kHz or more (measured in the same voltage range)	±0.1 dB
Channel to channel phase accuracy	Less than 20 kHz	±0.3 deg
	20 kHz or more	±0.7 deg
Anti-aliasing filter	4th order Butterworth: LPF 450 kHz, -3 dB	
Digital filter	FFT aliasing filter	At baseband: 10th order ellipse At zooming: 6th order ellipse
	Real-time octave band Filter	6th order Butterworth IEC 61260-1:2014 Class 1 JIS C 1513-1:2020 Class 1 (Compatible in terms of the filter shape)
	Acoustic filter	A and C frequency weightings IEC 61672-1:2013 Class 1 ANSI S1.4-2014/Part 1 Class 1 JIS C 1509-1:2017 Class 1 (Compatible in terms of the filter shape)
External sampling input	Input connector	BNC (CO2 type)
	Input voltage range	±12 V
	Input impedance	100 kΩ
	Input coupling	DC or AC
	Detection level	-12 V to +12 V step 0.025 V
	Slope	+ (Rising) or - (Falling)
	Hysteresis level	Optional setting (default 0.5 V, range 0.025 V to 24 V)
	Input frequency range	0 to 300 kHz (out-of-band filter 300 kHz, -3 dB)
	Absolute maximum input voltage	30 VAC/30 VDC
	Number of input pulses/rotations	0.5 to 1024 P/R
	Input pulse frequency divider function	1 to 1024 dividing, step 1 It is necessary when input frequency is over 4 kHz.
	Waveform monitor	Waveforms can be checked on the screen.
	External sampling input LED	Green LED (EXT SAMP) lights when pulse is detected.
External trigger input	Input connector	BNC (CO2 type)
	Input voltage range	±12 V
	Input impedance	100 kΩ
	Input coupling	DC or AC
	Detection level	-12 V to +12 V step 0.025 V
	Slope	+ (Rising) or - (Falling)
	Hysteresis level	Optional setting (default 0.5 V, range 0.025 V to 24 V)
	Input frequency range	0 to 300 kHz (out-of-band filter 300 kHz, -3 dB)
	Absolute maximum input voltage	30 VAC/30 VDC
	Waveform monitor	Waveforms can be checked on the screen.
	External trigger input LED	Green LED (EXT TRIG) lights when pulse is detected.

**2. Display Unit**

Size	10.4-inch
Resolution	800 × 600 dots*
Method	TFT color LCD with capacitance type touch panel
Brightness adjustment	2 levels (bright/dark)
Lighting (Back light)	LED

\* The ratio of the number of effective dots: 99.999 % or more.  
The TFT color LCD is created by the full use of advanced technology. However, the pixels (dots) of non-lighting or always lighting occasionally exist in the display. (The ratio of the number of effective dots: 99.999 % or more of 800 × 600 dots.) Also, unevenness of the color or brightness may be visible depending on the viewing angle or the temperature change. This is not a product failure, so please note that return or exchange of the product cannot be accepted.

**3. Operation Section**

Power switch	ON/OFF: Hold the switch for a few seconds. Holding the switch for more than 5 seconds will result in forced power-off.
Operation keys (Soft keys)	Detailed settings for each function can be performed by soft keys lower on the LCD display
Operation keys (Direct keys)	Cursor & selector key Right and left, up and down, SEARCH, /SET, ESC
	Switches of measurement SCHED, TRIG ON, AVG, START, STOP etc.
	Waveform selector TIME, SPECT, PHASE, FRF, COH, C-SPECT, SELECT
	Misoperation preventing function Press and hold SELECT to lock, unlock the soft key & direct key (excluding power switch).
	Printing key PRINT: Enables direct print of the screen displayed while connecting the recommended printer.
	Auto sequence play key AUTO SEQ: Reproduces the registered continuous operation content
	Frequency range selector key FREQ right and left
	Y-axis scale selector key Y SCALE up and down
	Signal output ON/OFF SIGNAL OUT (Available when the CF-0971 option is installed.)

**4. Analysis Section**

Frequency range	100 mHz to 100 kHz	
Frequency accuracy	±0.005 % (±50 ppm) of the reading values	
Sampling frequency	Frequency range × 2.56 (Internal sampling)	
Number of sampling points / analysis points	Number of Sampling points	Number of Analysis points
	256	100
	512	200
	1024	400
	2048	800
	4096	1600
	8192	3200
	16384	6400
Overlap processing	Max, 66.7%, 50%, 0%, customized	
Window function	Rectangular/Hanning/flat-top/force/exponential/user-defined	
Delay function	With reference to channel 1, time frame of other channels can be delayed by 0 to 8191 points.	
Time waveform processing function	First and second order differentials/single and double integrals, absolute value conversion/DC cancel/trend elimination/smoothing	
FFT real-time rate	100 kHz/4ch (Internal sampling, FFT frame length 2048 points or less)	
Averaging function	Number of averaging setup: 1 to 65535 times Averaging setup time: 0.1 to 999.9 seconds *Averaging can be stopped in terms of the number of times or time	
	Time domain	Summation average / exponential average
	Frequency domain	Summation average / exponential average / peak hold / subtraction average Sweep average / Fourier average / Max OA
	Amplitude domain	Summation average
	A/D-over cancel / double hammer cancel / averaging undo function	
Trigger function	Green LED (TRIG'D) blinks when triggered	
	Trigger level	-99 to 99 (Unit: %) Default: 25 % Threshold value can be set by amplitude unit (including user calibration value).
	Hysteresis level	0 to 99 (Unit: %) Default: 2 %
	Position	±16383
	Mode	Free/repeat/single/one-shot
	Source	Ch1/Ch2 (CF-9200A) to Ch3/Ch4 (CF-9400A)/ external trigger input
	Slope	+/-/± (Internal trigger) +/- (External trigger)
FFT calculation	32-bit floating point (IEEE single-precision format)	

**5. Processing Functions**

Time domain	Time waveform/auto-correlation function/cross-correlation function/impulse response/cepstrum
Amplitude domain	Amplitude probability density function/amplitude probability distribution function
Frequency domain	Power spectrum/Fourier spectrum/filtered spectrum/cross spectrum/frequency response function/coherence function/coherence output power
Calculation function (Time-axis statistical processing)	Mean value/absolute mean value/rms value/standard deviation/maximum value/minimum value/crest factor/skewness/kurtosis

**6. Memory Functions**

Recording device	Integrated storage or SD card	
Recording function	Frequency range	100 kHz (max.)
	Recording channel	Ch1/Ch2 (CF-9200A), Ch1 to Ch4 (CF-9400A) Also rotation information recording is possible.
	Recording time	Approx. 32 min. (At 50 kHz range 4ch recording, rotation information OFF, (max. 4 GB))
	Marker	Pressing [ESC] during recording allows marking.
	Recording format	ORF
	Maximum recording capacity	Internal storage approx. 6 GB SD/SDHC/SDXC (max. SDXC (128 GB))
Data file	9990 (999 data × 10 blocks) data Data can be saved in DAT/TXT/BMP/TRC formats.	
Panel condition memory	Memorizes and recalls measurement conditions. (50 types max.)	
Handwritten memo memory	Hand written memo on the touch panel can be recorded.	

**7. Interfaces**

USB	No. of ports USB (Type A)	(USB3.0 × 2, USB2.0 × 1) For USB flash drives (USB3.0 and USB2.0), wireless LAN modules, and Bluetooth modules
Wireless connection	Wireless LAN module Bluetooth* module	made by TP-LINK made by TP-LINK
SD	No. of ports	1
	SD/SDHC/SDXC compatible	Capacity: max. SDXC 128 GB*
LAN	No. of slots	1
	10BASE-T, 100BASE-TX, 1000BASE-T	Remote desk top, external control
Printer output	Press the PRINT key to print.	
	Interface	USB or Bluetooth* (With Bluetooth* module attached)
	Printer type	MW-270 made by Brother Industries, Ltd.
	Output data	Screen or list

\* Not guaranteed all types of SD, SDHC, SDXC card.

**8. Other Function**

Condition view	List display of specified conditions
Clock	Year, month, and date in western calendar Hour, minute, and second display
Operation sound/ alarm sound	Can be specified ON/OFF

**9. General Specification**

Power supply	AC adapter or batteries (Both provided as standard)	
Power consumption	CF-9400A (When the CF-0971 Signal Output option is installed.)	87 VA or less (When AC adapter is used, not battery charging) 150 VA or less (AC adapter is used, battery charging)
	CF-9200A (When the CF-0971 Signal Output option is installed.)	73 VA or less (AC adapter is used, not battery charging) 150 VA or less (AC adapter is used, battery charging)
Operating temperature range	0 to +40 °C (Humidity 20 to 80 % RH, with no condensation)	
Storage temperature range	-10 to +50 °C (Including lithium ion secondary batteries) (Humidity 20 to 80 % RH, with no condensation)	
Functional ground terminal	Grounding terminal for noise elimination (M3, binding head screw M3×L6 recommended)	
Outer dimensions	Smaller than 333(W)×248(H)×112(D) mm or less *Not including handle, stand or protruded sections.	
Main unit cooling	Naturally air-cooling (Fanless)	
Weight	Without batteries: Approx. 3.8 kg With two batteries: Approx. 4.8 kg	
CE marking	Low Voltage Directive: 2014/35/EU EN61010-1 EMC Directive: 2014/30/EU EN61326-1 RoHS Directive: 2011/65/EU EN IEC 63000	
Accessories	Battery	× 2
	SD card	× 1
	AC adapter	× 1
	CF-9200A/CF-9400A User Guide (booklet)	× 1
	CD-ROM (Softwar reference guide, utility software, external control DLL)	× 1

**10. AC Adapter (PS-P20023F)**

Input voltage	100 to 240 VAC
Input frequency	50/60 Hz
Output voltage	Rated 16 V
Output current	4 A
Safety standard	PSE/CE/UL/GS

**11. Battery**

Battery	Lithium ion secondary batteries Mounted in main unit ("Hot swap" available)	
Quantity	Two batteries can be mounted.	
Drive time	8 hours (new batteries) • 4CH 100 kHz analysis; signal output OFF; USB ports open; LCD back light (light)	
Battery status display	Main unit screen	Displays the remaining battery level on the main unit screen when operating on the secondary battery.
	Battery LED (BATT 1, BATT2)	Orange LED is on during charging, green LED is on when full charged. (When connecting AC adapter) Red LED is on when LOW BATT (When remaining battery becomes less than 5 % and not mounted AC adapter)
	Indication	Charge completed, Charging, Stop charging, Not installed, LOW BATT
Actions at minimum charge level	Remaining charge warning message displayed at 3 % or lower charge level and automatic shutdown after data backup Stores the latest panel condition	
Charging time	Analyzer in operation	Approx. 7 or 8 hours (depending on operating conditions)
	With power OFF	Approx. 7 or 8 hours
	With external charger (optional)	Approx. 4.5 or 5 hours

\* When ambient temperature is 10 °C or less, turn on the power of the main unit and charge it. Charging is restricted or stopped when charging in a low temperature environment of 10 °C or less in the power off state.

## Optional Specification

### Tracking Analysis CF-0922

Tracking analysis type	Phase
	Amplitude
Sampling method	Constant ratio tracking (external sampling): Up to maximum frequency analysis order Constant width tracking (internal sampling): Frequency range is the same as that of FFT analysis
Number of FFT sampling points	256 to 16384 points (power-of-two step)
Averaging function	Power spectrum exponential average Fourier spectrum exponential average
Max. analysis orders	6.25, 12.5, 25, 50, 100, 200, 400, 800
Max. number of blocks	100, 200, 400, 800, 1000
Analysis screen display	6 screens/list display of tracking available
Display function	Time-axis waveform, frequency analysis (amplitude, phase), order ratio analysis (amplitude, phase), constant-ratio tracking analysis (amplitude, phase), constant-width tracking analysis (amplitude, phase), fixed-frequency tracking analysis (amplitude, phase), time-tracking analysis (amplitude, phase), 3D map, Campbell plot
Number of display tracking diagrams	8 lines (excluding MAX ord, O.A)
Schedule function	Rotation schedule (with automatic judging of decreasing rotation speed) Time schedule (time trend)
Upper and lower limitation setting of rotation	UP (lower limit → upper limit) DOWN (upper limit → lower limit) UP/DOWN (lower limit → upper limit → lower limit) DOWN/UP (upper limit → lower limit → upper limit)
Simultaneous recording & analysis function	Available for constant-width tracking

### Real-time Octave Analysis (RTA) CF-0923

Octave type	1/1 octave 1/3 octave (filter: 6th order Butterworth) IEC 61260 Ed.1.0 (1995) Class 1, JIS C 1514: 2002 Class 1 ANSI S1.11: 2004 Class 1
Time weighting (Time constant)	10 ms, 35 ms, 125 ms (FAST), 630 ms, 1 s (SLOW), 8 s IMPULSE rising 35 ms/falling 1.5 s IEC 61672-1: 2002 Class 1, JIS C 1509-1: 2005 Class 1
Analysis frequency range	0.8 to 20 kHz (1/3 octave) 1 to 16 kHz (1/1 octave)
Calculation function	Instantaneous value, maximum value of every one second, maximum value hold, and minimum value hold, power averaging value, power summation value, linear Leq
Analysis screen display	Up to 6 screens (Data overlay display available) List display of real-time octave
Simultaneous recording & analysis function	Available
Option	CF-0922 (Tracking Analysis)

### LAN External Control Function CF-0947

<Recommended environment>

Client PC (OS)	Microsoft® Windows® 10
Software	10Microsoft® Visual Studio® 2019 (VB, C#) Microsoft® Office Excel® 2016
.NET	Microsoft® .NET Framework 4
Network cable	LAN cable* Category 6

\* Some terminal may not be connected through a straight cable. When using a straight cable, ensure that the terminal used supports auto MDI/MDI-X.

### Log Sweep/Excitation Control CF-0942

Measurement mode (FRA mode)	
Dynamic range	150 dB (FRA)
Measurement frequency range	10 mHz to 100 kHz
Frequency resolution (Log sweep)	10, 20, 40, 50, 80, 100, 120, 160, 200, 250, 300, 320, 400, 500 lines/decade
Frequency resolution (Linear sweep)	100, 200, 400, 500, 800, 1000, 2000, 2500, 4000, 5000 lines/all band of the measurement frequency range
Number of times of averagings	1, 2, 3, 4, 5, 6, 7, 8, 9, 10, 20, 25, 30, 40, 50, 60, 80, 100, 120, 150, 180, 200 times and optional number of times
Frequency range dividing setup mode	Addition times and signal output level can be changed for each measurement frequency range which is divided into up to 10.
Frequency resolution auto adjusting function	Automatically adjusts the decade of each frequency band and resolution to see the frequency characteristics accurately.
Frequency resolution increase function	Enables remeasurement of the specified frequency range resolution with a resolution 20 times the first measurement.
Calculation function	Frequency axis differential and integral calculus function (first order differential, second order differential, single integral, double integral), four arithmetic operation

Display	
Display of Frequency Response Function	Bode diagram (horizontal axis: frequency/vertical axis: gain and phase) Nyquist diagram (horizontal axis: real number part/vertical axis: imaginary number part) enables logarithmic scale display of amplitude
Display mode	FRF mode (triple screen display) 1)FRF (Bode diagram), COH (enables ON, OFF of display) 2)Nyquist or SPEC (1, 2ch overlay) 3)TIME, instantaneous spectrum (enables overlay display and specifying channel.) List mode (single screen display) 1)Measurement condition 2)List of No./frequency/FRF gain/FRF phase/COH/FRF real number part/FRF imaginary number part/SPEC1/SPEC2/number of summations for all measurement data Peak List mode (double or triple screen display) List of frequency, gain and phase on the FRF bode diagram display using two ways. 1. Peak point of gain (automatic search) 2. Optionally specified point Memory mode 1)FRF of current status data 2)List of saved waveforms 3)Overlay display of waveforms selected from 2) (Up to 8 screens) Calculation screen (Quad screen display) 1)FRF of current status data 2)FRF of saved data 3)Waveform of four arithmetic operations and differential and integral calculus of 1), 2)/ Waveform of open and close loop conversion of 1), 2) * Waveform of calculation result also can be displayed. 4)Nyquist diagram of calculation result of 3)
Display function	Phase unwrap display Search delta function

### Signal Output (CF-0971 1CH Signal Output Module): Hardware Option

Number of channels	1	
Output connector	BNC (C02 type)	
Isolation	Non-isolated	
Output voltage amplitude	±1 mV to ±10 V (amplitude + DC offset)	
Offset voltage	±10 V	
Output format	Unbalanced output	
Output coupling	DC	
Protection circuit	Short-circuit protection	
Output impedance	0 Ω or 50 Ω±10 %	
Maximum output current	10 mA	
D/A convertor	16-bit	
Conversion rate	max. 512 kHz	
Output waveform	Sine wave/swept-sine/pseudo random/random/impulse	
THD and spurious	-75 dB or less (at sine wave 1 kHz, amplitude ±1 V output)	
FFT Analysis length	256 to 16384	
Zoom analysis	Available (linked with the zoom analysis range)	
Voltage amplitude accuracy	±0.5 dB or less (at 1 kHz, 1 V <sub>0-p</sub> , 1 MΩ load)	
Frequency accuracy	±50 ppm	
Digital filter	Smoothing filter	At baseband: 10th order ellipse At zooming: 6th order ellipse
	Octave band filter	1/1 or 1/3 octave 6th order Butterworth
Pink filter	Analog method -3 dB/oct ± 1.0 dB (prescribed for 20 Hz to 20 kHz)	
Burst function	Single burst, continuous burst	
Burst cycle	Sine wave	1 to 32767 cycles
	Swept-sine/pseudo random/impulse	1 to 32767 FFT frames
	Random	1 ms to 32 s
Cycle setting unit and burst interval	Sine wave	Sine wave 1 cycle
	Swept-sine/pseudo random/impulse	1 FFT frame
	Random	1 ms
Taper function	Can be set individually when the signal is turned ON or OFF 1 ms to 32 s (1 ms-steps) This function is not available when the burst function is ON.	
Spectrum flatness	20 kHz to 100 kHz	±1.0 dB or less
	0 to 20 kHz	±0.2 dB or less
Crest factor	Sine wave	Approx. 1.41
	Swept-sine	Approx. 1.4 to 1.6
	Pseudo random	3.3 or less
	Random	3.3 or less
	Impulse	32.0 or less

### Product list

Main unit	
Model name	Product name
CF-9200A	Portable 2ch FFT Analyzer
CF-9400A	Portable 4ch FFT Analyzer

\* Please refer to P.13 \*9. General specification\* for accessories.

Options	
Model name	Product name
CF-0922	Tracking Analysis Function
CF-0923	Real-time Octave Analysis (RTA) Function
CF-0942	Log Sweep/Vibration Control Function*1
CF-0947	LAN External Control Function (Software option)
CF-0971	1 ch Signal Output Module*2
CF-0951A	Reference Guide (Japanese version)
CF-0951AE	Reference Guide (English version)
CC-0025A	Soft Carrying Case
CC-0091	Hard Carrying Case
RRC2020 (100496-15)	Battery
PS-P20025A	Battery charger set

\*1 CF-0971 is required.

\*2 The additional fee is required when adding after delivery of the main unit.



**CF-9200A**

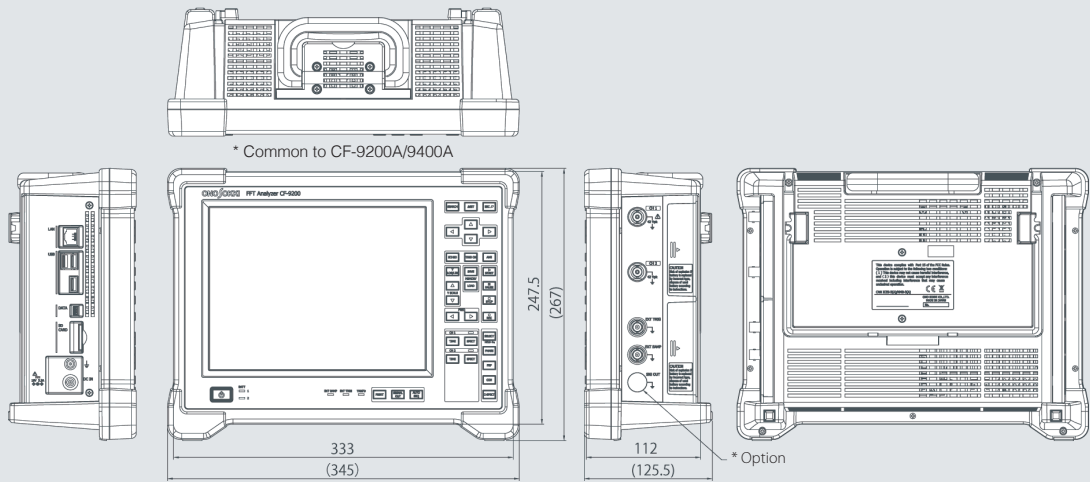

\* Option: BNC (C02 type) is mounted when CF-0971 (1CH Signal Output Module) is installed.

**CF-9400A**

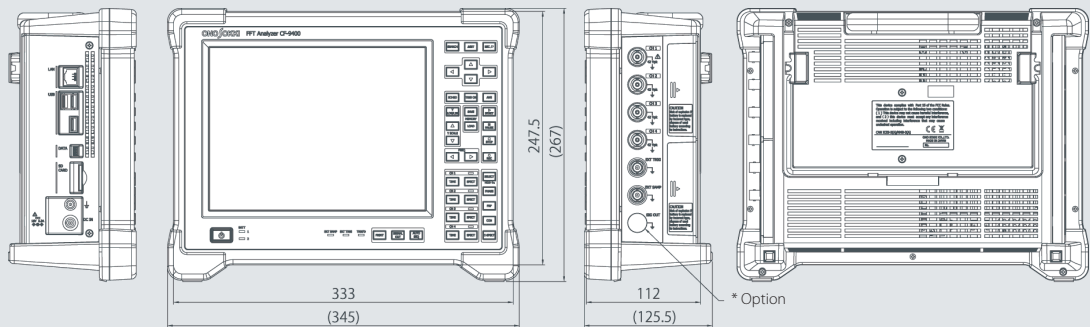

\* Option: BNC (C02 type) is mounted when CF-0971 (1CH Signal Output Module) is installed.

**Soft Carrying Case CC-0025A**

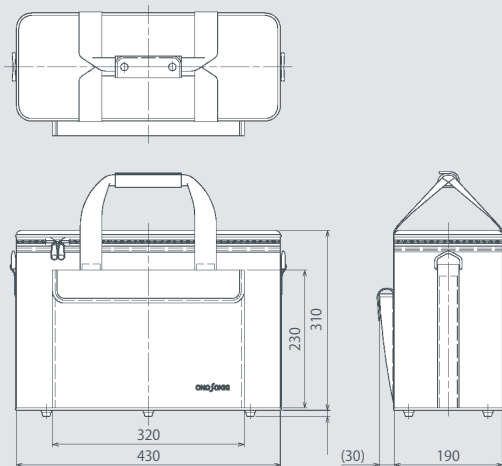

**Hard Carrying Case CC-0091**

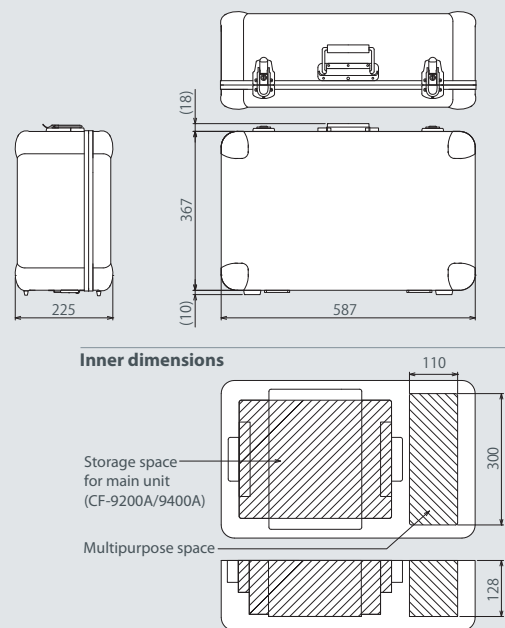

- \* Microsoft®, Windows® are registered trademarks of Microsoft® corporation in the United States and other countries.
- \* Bluetooth® is a registered trademark of Bluetooth SIG, Inc. in the United States and other countries.
- \* Other company names, product names and model names are trademarks or registered trademarks of each individual company. The copyrights are reserved by each individual company.



**WORLDWIDE ONO SOKKI CO., LTD.**  
 3-9-3 Shin-Yokohama, Kohoku-ku, Yokohama, 222-8507, Japan  
 Phone : +81-45-476-9725 Fax : +81-45-476-9726  
 E-mail : overseas@onosokki.co.jp

\* Outer appearance and specifications are subject to change without prior notice.  
**URL : <https://www.onosokki.co.jp/English/english.htm>**

**U.S.A.**  
 Ono Sokki Technology Inc.  
 2171 Executive Drive, Suite 400  
 Addison, IL. 60101, U.S.A.  
 Phone : +1-630-627-9700  
 Fax : +1-630-627-0004  
 E-mail : info@onosokki.net  
<https://www.onosokki.net>

**THAILAND**  
 Ono Sokki (Thailand) Co., Ltd.  
 1/293-4 Moo.9 T.Bangphud  
 A.Pakkred  
 Nonthaburi 11120, Thailand  
 Phone : +66-2-584-6735  
 Fax : +66-2-584-6740  
 E-mail : sales@onosokki.co.th

**INDIA**  
 Ono Sokki India Private Ltd.  
 Plot No.20, Ground Floor, Sector-3,  
 IMT Manesar Gurgaon-122050,  
 Haryana, INDIA  
 Phone : +91-124-421-1807  
 Fax : +91-124-421-1809  
 E-mail : osid@onosokki.co.in

**P.R.CHINA**  
 Ono Sokki Shanghai Technology Co., Ltd.  
 Room 506, No.47 Zhengyi Road, Yangpu  
 District, Shanghai, 200433, P.R.C.  
 Phone : +86-21-6503-2656  
 Fax : +86-21-6506-0327  
 E-mail : admin@shonosokki.com

