

ONO SOKKI

CT-6520

DIGITAL ENGINE TACHOMETER
INSTRUCTION MANUAL

ONO SOKKI CO., LTD.

1. This document may not be reproduced, in whole or part, in any form or by any means without the prior written permission of the publisher.
2. The contents of this document are subject to change without notice.
3. This document has been produced based on a series of strict verifications and inspections. Should a failure occur nonetheless, please inform our sales representative or sales office.
4. Ono Sokki shall have no liability for any effect resulting from any operation, whether or not the effect is attributable to a defect in the documentation.

Copyright © ONO SOKKI CO., Ltd. 2000 All rights reserved.

Warranty

1. This product is covered by a warranty for a period of one year from the date of purchase.
 2. This warranty covers free-of-charge repair for defects judged to be the responsibility of the manufacturer, i.e., defects occurred while the product is used under normal operating conditions according to descriptions in this manual and notices on the unit label.
 3. For free-of-charge repair, contact either your sales representative or our sales office nearby.
 4. The following failures will be handled on a fee basis even during the warranty period.
 - (a) Failures occurring through misuse, mis-operation, or modification
 - (b) Failures occurring through mishandling (dropping) or transportation
 - (c) Failures occurring through natural calamities (fires, earthquakes, flooding, and lightning), environmental disruption, or abnormal voltage.
- * For repairs after the warranty period expired, contact your sales representative or our sales office nearby.

FOREWORD

This manual describes the functions and specifications of the CT-6520 digital engine tachometer as well as connection procedure and notes on use for the product.

Before starting operation, please read this instruction manual to ensure proper use of the CT-6520. In particular, the manual contains some warnings and cautions which may cause property damages if not observed. Be sure to handle the product according to the handling procedures described in the manual. As the manual acts as a warranty card, store it in a safe place after reading it.

This manual covers only the CT-6520 digital engine tachometer. For other equipment to be used together with the CT-6520 (such as sensors, printers, and recorders), see each individual manuals.

■ PRODUCT OVERVIEW

The CT-6520 is an engine tachometer which uses a multiplication circuit to reduce the measurement time and ensure high accuracy. By simply setting a switch to the number of pulses per revolution in the input signal, it is possible to perform r/min measurements on all types of engines. In addition, it can be used as a multi-function tachometer.

■ FEATURES

- A wide variety of engine types can be handled easily by simply selecting the sensor to be used with the engine under test.
- The CT-6520 can be used with sensors to enable engine r/min measurement of 2/4-cycle engines having from one to eight cylinders.
- The number of input pulses per revolution can be set in a range from 0.5 to 199.5 pulses per revolution in 0.5-P/R steps.
- The CT-6520 is provided with digital, analog, and pulse output terminals.
- The pulse output can be selected as 1 P/R, 60 P/R or as a wave-shaped output of the input signal.
- The CT-6520 has a dual (AC/DC) power supply which enables use on both an indoor test bench and mounted in vehicles.

Notes:

1. Before shipment, the CT-6520 has been tested through severe inspections to verify normal operation.
2. When you unpack the unit, make sure that you have all the parts and that none have been damaged during transportation. Then check whether the CT-6520 operates normally.
3. If any parts is damaged or missing or the CT-6520 does not operate normally, please contact the retail store where you bought the product or your nearest Ono Sokki sales office.

FOR YOUR SAFETY



Please read this document and the product instruction manual to ensure safe and proper use of the CT-6520. Store these documents in a safe place after reading them.

Ono Sokki, Ltd. bears no responsibility for nor makes any warranty regarding damages or injury resulting from failure to follow directions given within this document during operation.

Meaning of Symbols

● Warnings and cautions

In this document precautions are classified into two categories: WARNING and CAUTION. This depends on the degree of danger or damage possible if the precaution is ignored and the product is used incorrectly.

 WARNING	This symbol is used to indicate precautions where there is a risk of death or serious personal injury to the operator if the product is handled incorrectly.
 CAUTION	This symbol is used to indicate precautions where there is a risk of some personal injury to the operator or only material damage to the product if the product is handled incorrectly.



Before Using

- Only use fuses with the specified rating as using incorrect fuses may cause fire. Also, turn the power off and unplug the power cord for at least one minute before replacing fuses.
- Avoid using the product on locations subject to high temperature as there may be a risk of fire. Avoid using the product on locations with extremely high temperature. Using the product on locations with a temperature exceeding the rated operating temperature range may cause fire.
- Do not block the heat radiation system as there is a risk of fire if heat builds up inside the product. Place the product away from the wall on locations with the best ventilation possible.
- Do not remove the casing or take apart this product. Using the product without its casing or while taken apart may cause damage to the product or electric shock. When internal adjustment, inspection, or repairs are required, contact the retail store where you bought the product or your nearest Ono Sokki sales office.
- Do not splash or spill water on the product, as doing so may cause fire or electric shock due to short or increased heat. If water does happen to get inside the product, unplug the power cord immediately and call the retail store where you bought the product or your nearest Ono Sokki sales office as soon as possible.



WARNING

Precautions Regarding Electric Shock

- Never cut the internal or external ground wire of the product or disconnect the wire connected to the protective ground terminal of the product, as doing so may cause electric shock or damage to the product.
- Before connecting the product to a device to be measured or external circuit, check that the product is properly grounded and that the power is turned off. Connecting the product to external equipment while not grounded or while power is still on may cause electric shock.
- Make sure that the power is turned off before touching the voltage/current output section or circuits connected to the voltage/current output section. Touching such parts while the power is on may cause electric shock. Be sure to sufficiently insulate circuits from output voltage/current.
- Make sure that the power always meets specified voltage and frequency requirements. Using the power not meeting the requirements may cause electric shock, fire, or damage to the product.
- If you hear thunder, do not touch any metallic parts of the product or the plug as there is a risk of electric shock from conducted lighting. Do not use this product outdoors if you hear thunder.



WARNING

About Protective Grounding

Be sure that protective grounding is performed by any of the following methods before supplying the power to a terminal marked with this symbol. Failure to provide protective grounding may cause electric shock.

- * If a three-pronged power cord (one prong for ground) is supplied with the product, use the product with a three-pronged outlet which has been grounded.

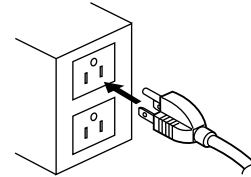

- * If a 3-way-to-2-way adaptor is used with the power cord supplied with the product, be sure that the ground wire of the adaptor is securely grounded on the power supply side.

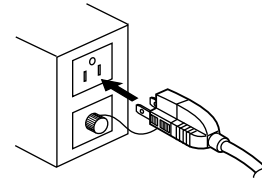



WARNING

About the Power Cord

- Only use the power cord or AC adaptor supplied with the product or one specified by Ono Sokki. Use of power cords or AC adapters other than the one specified may cause electric shock or fire.



WARNING

If a Problem Occurs

- Unplug the product immediately if any metal, water, or foreign object should fall inside. Continued operation of the product with metal, water, or foreign object inside may cause fire or electric shock. After unplugging the unit immediately, contact the retail store where you bought the product or your nearest Ono Sokki sales office as soon as possible.
- Unplug the product if you perceive smoke, strange noise, or strange smell coming from the product or if you accidentally drop it or damage it. Continued operation of the product may cause fire or electric shock. After immediately unplugging the product, contact the retail store where you bought the product or your nearest Ono Sokki sales office as soon as possible.



CAUTION

About Installation and Connections

- Do not install the product on unstable locations. If the product should fall, injury or damage to the product may result.
- Do not place large or heavy objects on top of the product. If an object on top of the product should fall, injury or damage to the product may result.
- Do not install the product on locations where oily smoke, steam, or dust is present or where the humidity is high. Electricity could conduct through oil, water vapor, or dust resulting in fire or electric shock.
- Do not install the product on locations subject to extremely high temperature or do not expose it to direct sunlight, as doing so may cause fire.



CAUTION

About the Power Cord

- Be sure to hold onto the plug portion when plugging or unplugging the power cord. Pulling on the cord may damage or break the cord possibly resulting in fire or electric shock.
- Do not plug or unplug the power cord with your hands wet.
- Keep the power cord away from heaters or other heat generating appliances, as the cord casing may melt resulting in fire or electric shock.
- To prevent electric shock due to inferior insulation or fire due to leakage current, when the product is not to be used for a long period of time, unplug the power cord or turn off the breaker of the distribution board.



CAUTION

Measurement

- Do not change the setting of the sensor switch, input pulse switch, or pulse signal output switch during measurement, as doing so may cause measurement error and abnormal signal to be output to external equipment.
- Do not disconnect any input or output connectors during measurement, as doing so may cause measurement error and abnormal signal to be output to external equipment.
- Do not turn off the power during measurement, as doing so may cause measurement error and abnormal signal to be output to external equipment.



CAUTION

Checking the Supplies

- When you receive the unit, make sure that you have all the parts and that none have been damaged during transportation. If any parts is damaged or missing, contact the retail store where you bought the product or your nearest Ono Sokki sales office.

Name	Qty	Remarks
AC power cable	1	3P-3P 1.9 m
DC power cable	1	3.5 m
Conversion adapter (CM-33)	1	For AC cable (3P to 2P)
AC power fuse	1	0.5A midzet fuse
DC power fuse	1	2.0A midzet fuse
Instruction manual	1	(this manual)

CONTENTS

PREFACE

FOR YOUR SAFETY

1. SYSTEM CONFIGURATION	1
2. NAME AND FUNCTION OF EACH SECTION	2
2.1 Front Panel	2
2.2 Rear Panel	6
3. Measurement, Setting, and Adjustment Procedures	10
3.1 Measurement Procedure	10
3.2 Adjustment of the Input Trigger Level	13
3.3 Checking the Display and Output Voltage	15
4. SPECIFICATIONS	16
5. APPLICABLE SENSORS LIST	18
6. OUTSIDE DIMENSIONS	19

1. System Configuration

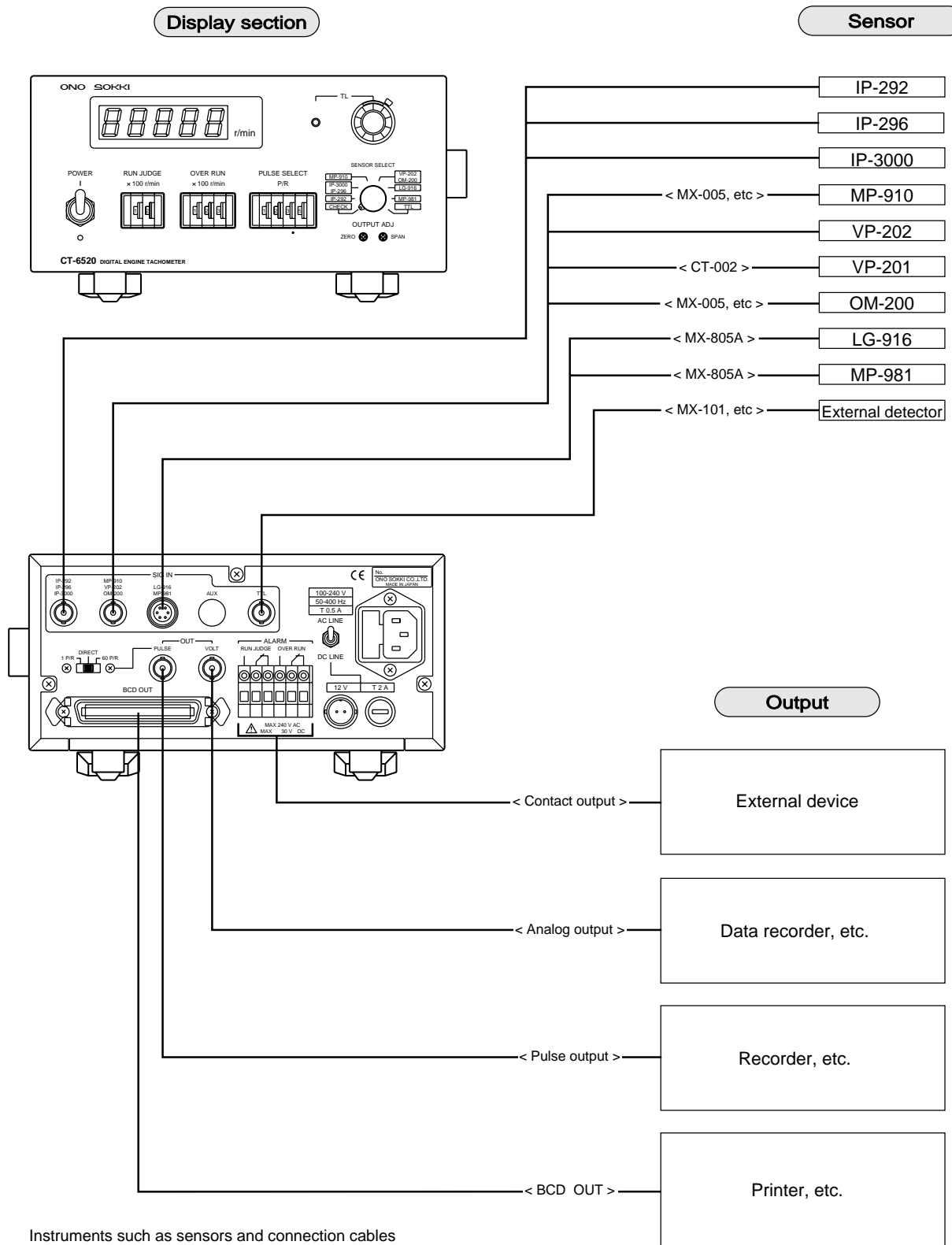

Instruments such as sensors and connection cables described in this manual are all options. Select options according to the purpose and usage of your application.

2. Name and Function of Each Section

2.1 Front Panel

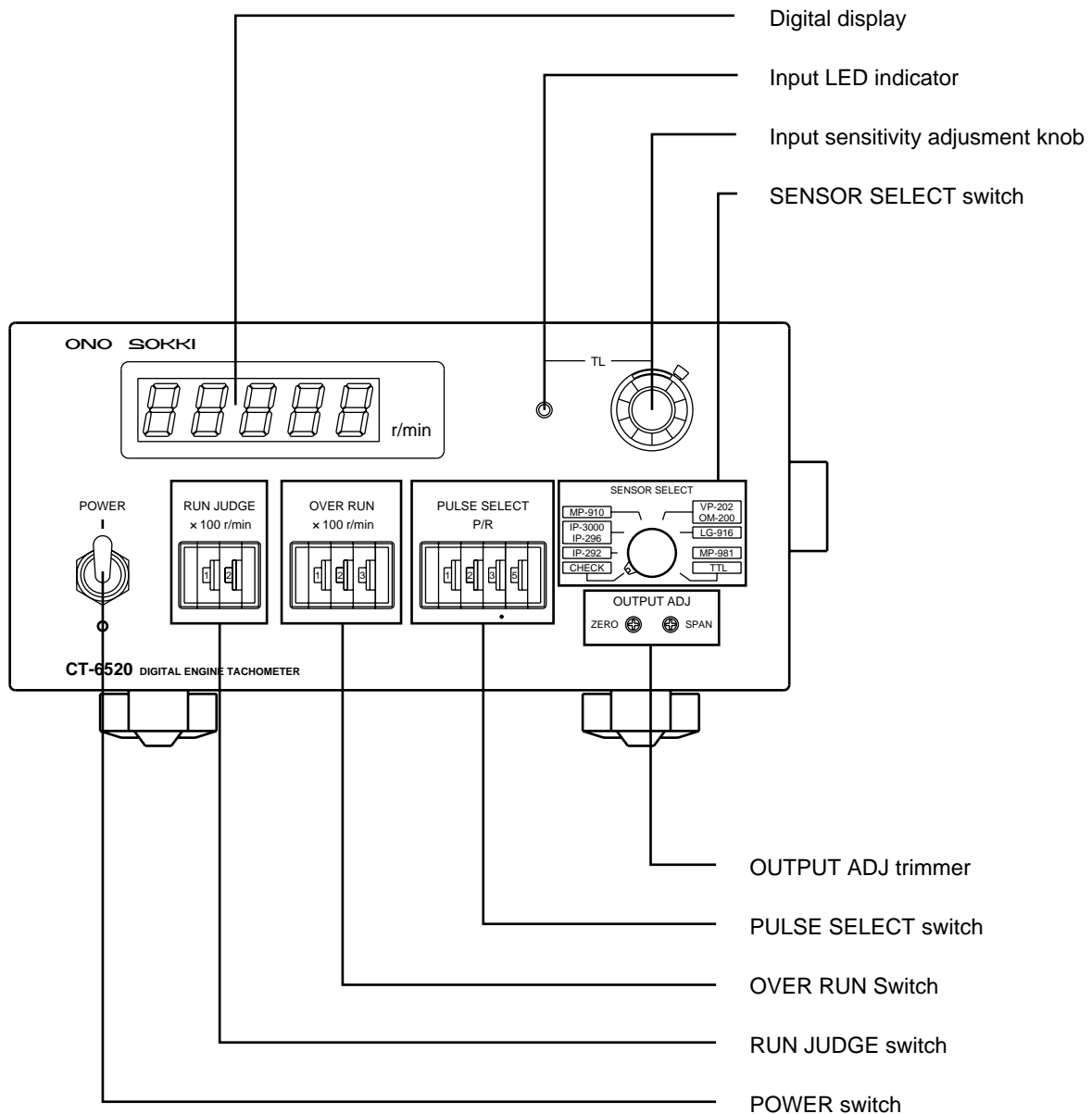

① Digital display

This green LED display indicates the r/min value ranging from 0 to 20000 r/min with zero suppression. When the setting of the SENSOR SELECT switch ④ is changed, the display will fluctuate for a few seconds. However, this is not a failure. Wait until display becomes stable and then restart measurement.

② Input LED indicator

This indicator operates in different manners depending on whether the IP-292/296/3000 ignition pulse sensor, VP-202 or OM-200 sensor is connected.

- When the IP-292/296/3000 ignition pulse sensor, VP-202 or OM-200 sensor is connected, this indicator is used as a level adjustment indicator for level adjustment by the input sensitivity adjustment knob ③. Turn the knob until this indicator goes on.
- When other sensors are connected, this indicator goes on.

③ Input sensitivity adjustment knob

Used to adjust the input sensitivity when the IP-292/296/3000 ignition pulse sensor, VP-202 or OM-200 sensor is connected.

The input trigger level for the IP-292/296/3000 ignition pulse sensor, VP-202 or OM-200 sensor differs according to the type of engine. When one of these sensors is connected, turn this knob to the clockwise or counterclockwise so that the input LED indicator ② flashes periodically during idling of the engine.

The input trigger level for other sensors is semifixed internally (i.e., level adjustment was made at the factory).

④ SENSOR SELECT switch

Used to select the type of the sensor used from the following:

- IP-292 : For primary side ignition on gasoline engines
- IP-296 : For secondary side ignition on gasoline engines
- IP-3000 : For primary and secondary side ignition on gasoline engines
- MP-910 : Gasoline or diesel engines and other rotating bodies
- VP-202 : 4-cylinder diesel and gasoline engines
- OM-200 : For gasoline engines
- LG-916 : Gasoline or diesel engines and other rotating bodies
- MP-981 : Gasoline or diesel engines and other rotating bodies
- TTL : For TTL level signal input from an external sensor
- CHECK : For checking analog or digital internal circuits

The CHECK switch may be used together with the PULSE SELECT switch ⑤. In this case, the digital display value and the output voltage for each input pulse count are as follows:

Input pulse count	Digital display	Output voltage (V)
0.5	10000	5.000
1.0	5000	2.500
1.5	3333	1.666
2.0	2500	1.250
2.5	2000	1.000
3.0	1666	0.833
4.0	1250	0.625
8.0	625	0.312

< Input pulse count and r/min measurement range when the IP-292/296/3000 is connected >

Sensor	Input pulse count	4-cycle engine	2-cycle engine	Rpm measurement range
IP-292 IP-3000	0.5	1 cylinder		400 to 20000 r/min
	1.0	2 cylinders	1 cylinder	400 to 20000 r/min
	1.5	3 cylinders		400 to 20000 r/min
	2.0	4 cylinders	2 cylinders	400 to 20000 r/min
	2.5	5 cylinders		400 to 20000 r/min
	3.0	6 cylinders	3 cylinders	400 to 15000 r/min
	4.0	8 cylinders	4 cylinders	400 to 11000 r/min
	6.0	12 cylinders		400 to 7500 r/min
IP-296 IP-3000	0.5	4-cycle engine		400 to 20000 r/min
	1.0	2-cycle engine		

< Input pulse count, input pulse range, and r/min measurement range when other sensors are connected >

Sensor	Input pulse count	Input pulse range	Rpm measurement range
MP-910/981	0.5 to 199.5	3 to 33000 P/s	400 to 20000 r/min
VP-202/OM-200	0.5 to 8.0	3 to 1000 P/s	400 to 20000 r/min
LG-916	1.0	6 to 166 P/s	400 to 10000 r/min
TTL input	0.5 to 199.5	3 to 33000 P/s	400 to 20000 r/min

Note: When the setting of the SENSOR SELECT switch ④ is changed, the display will fluctuate for a few seconds. However, this is not a failure. Wait until display becomes stable and then restart measurement.

⑤ OUTPUT ADJ trimmer

Used to adjust ZERO and SPAN of r/min analog output. The adjustment range for ZERO is $\pm 4\%$ of the full scale and that for SPAN is $\pm 4\%$ of the full scale.

⑥ PULSE SELECT switch

Used to set the pulse count for each revolution of the sensor. The correspondence of the sensor to the number of cylinders of the engine is shown in the table.

For pulse gears mounted on the engine shaft (1 to 199 P/R) or pulses coming from other measuring instruments (3 to 3300 P/s), set the PULSE SELECT switch to the pulse count shown below.

Sensor	IP-292 / IP-3000 / OM-200		IP-296 / IP-3000		VP-202		MP-910 / 981 (TTL)	LG-916
	2	4	2	4	2	4	2 / 4	2 / 4
1 cylinder	1.0	0.5	1.0	0.5	-	0.5	0.5 to 199.5	1.0
2 cylinders	2.0	1.0			-	1.0		
3 cylinders	3.0	1.5			-	1.5		
4 cylinders	4.0	2.0			4.0	2.0		
5 cylinders	-	2.5			-	2.5		
6 cylinders	-	3.0			-	3.0		
8 cylinders	-	4.0			-	4.0		

- Note:**
- For 2-cycle, 5-cylinder and 4-cycle, 10-cylinder engines (pulse selector set to 5.0), measurement cannot be performed using the IP-292 ignition pulse sensor.
 - With engines having dummy spark cycles, the relationship between the input pulse count and the number of cylinders will be different.
 - The above number of cylinders may differ according to the type of the ignition system used by the engine. For details, contact the retail store where you bought the product or your nearest Ono Sokki sales office.

⑦ OVER RUN setter

An engine speed limit can be set in the range between 100 and 19900 r/min in 100 r/min steps. If 50 is being set with the thumb wheel switches, for example, a signal will be output from the ALARM terminal and the BCD OUT connector on the rear panel when the engine speed exceeds 5000 r/min.

⑧ RUN JUDGE setter

An engine speed limit can be set in the range between 100 and 9900 r/min in 100 r/min steps. If 10 is being set with the thumb wheel switches, for example, a signal will be output from the ALARM terminal and the BCD OUT connector on the rear panel when the engine speed exceeds 1000 r/min.

⑨ POWER switch

This power switch can be used for 100 to 240 VAC or 12 VDC.

Setting this switch to the ON side turns on the power and setting it to the OFF side turns off the power. The power select switch on the rear panel switches between 100 to 240 VAC or 12VDC.

2.2 Rear Panel

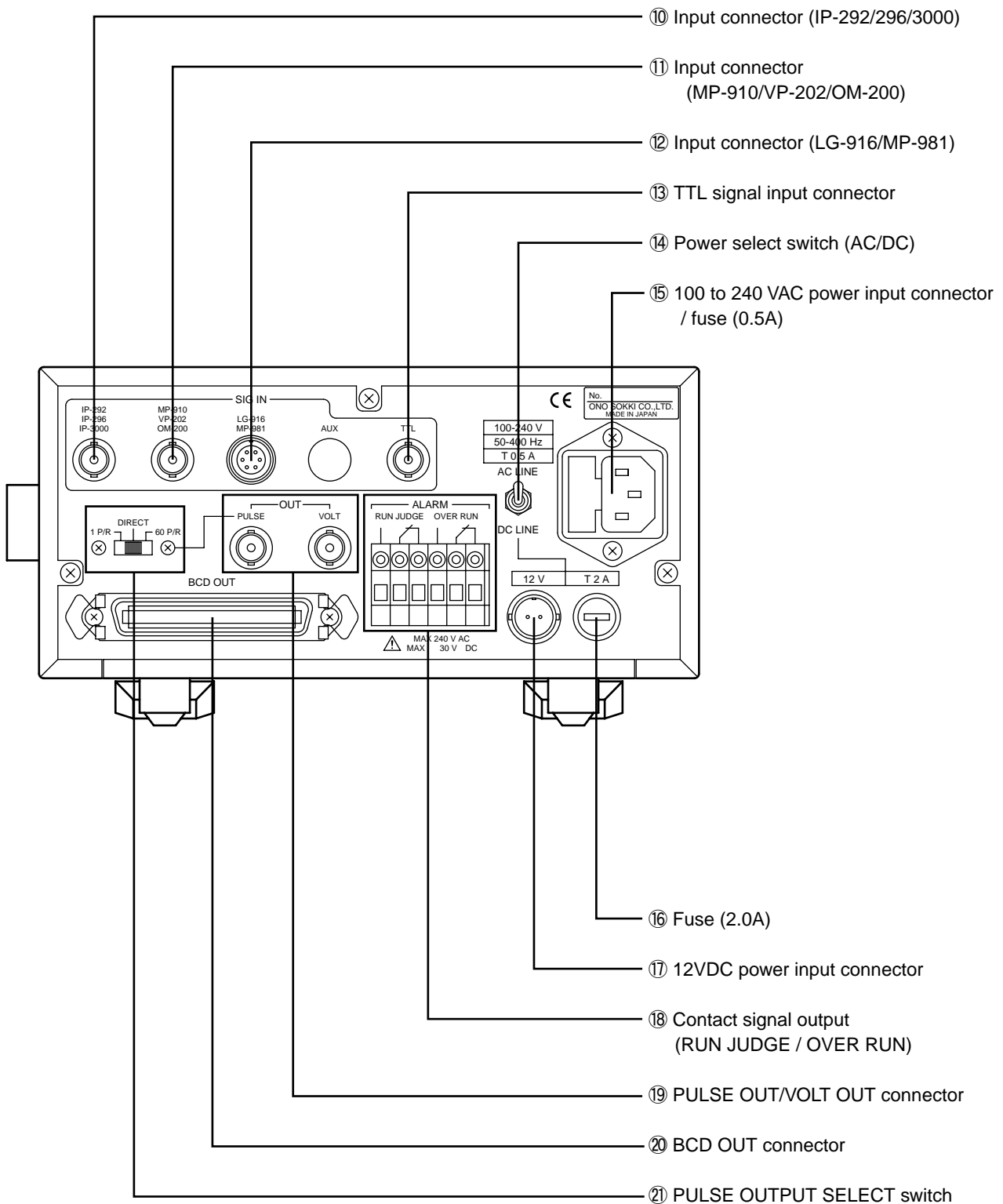

⑩ Input connector (IP-292/296/3000)

Used to input the signal from the IP-292/296/3000 ignition pulse sensor. The applicable connector type is BNC.

⑪ Input connector (MP-910/VP-202/OM-200)

Used to input the signal from the MP-910/OM-200 electromagnetic sensor and the VP-202 galvanic electricity vibration sensor. The applicable connector type is BNC.

⑫ Input connector

The input connector is used to input the signal from the MP-981 electromagnetic sensor and the LG-916 photoelectric sensor. The applicable connector type is R03-PB6M.

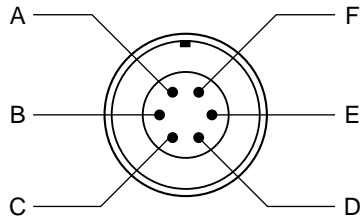

Pin No.	Signal
A	SIGNAL
B	Vacant
C	Power (+12V)
D	Shield
E	Common
F	Common

⑬ TTL signal input connector

Used to input TTL signal. The applicable connector type is BNC.

⑭ Power select switch

Used to switch between 100 to 240 VAC and 12 VDC.

⑮ 100 to 240 VAC power input connector/fuse (0.5A)

Used to supply 100 to 240 VAC (40 to 400 Hz) through the AC power cable.

The midget fuse (0.5A) is in the AC power connector to protect the internal circuits.

To prevent electric shock, fire, or damages to the unit, be sure to use a fuse with the specified rating.

⑯ Fuse (2.0A)

This 2.0A midget fuse is used to protect the internal circuits of the DC power supply.

To prevent electric shock, fire, or damages to the unit, be sure to use a fuse with the specified rating.

⑰ 12VDC power input connector

Used to supply 12 VDC power through the DC power cable. The applicable connector type is RM12BPG-2S.

Notes: • The supplied DC power cable is provided with red and black clips at one end. To prevent electric shock, fire, or damages to the unit, be sure to connect the red clip to the positive pole (+) and the black one to the negative pole (-).

⑱ Contact signal output terminal

Used to output the contact signal for RUN JUDGE and OVER RUN comparators. Each has a transfer contact with resistance load (240 VAC/2A, 30 VDC/2A).

Refer to the figure below for connection.

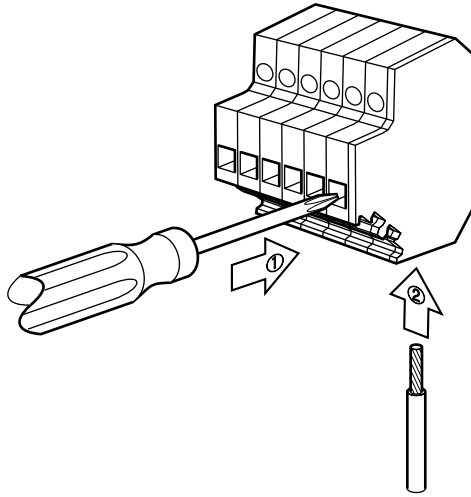

Insert a screwdriver into the rectangular hole and loosen the screw in it. Put a lead wire from the bottom of the terminal block and then tighten the screw in the hole to fix the wire.

⑲ PULSE OUT/VOLT OUT connectors

The pulse signal output connector (PULSE OUT) outputs the signal selected by the pulse output switch ⑳, with the TTL level (and a fan out of 2). The applicable connector type is BNC. (See the pin assignment below.)

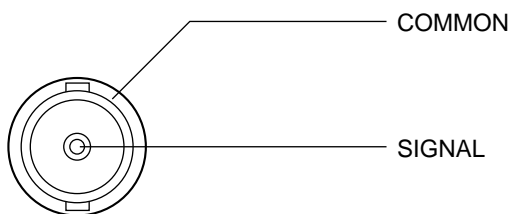

The analog signal output connector (VOLT OUT) outputs voltage from 0 to 10 V (corresponding to 0 to 20000 r/min). The applicable connector type is BNC. (See the pin assignment below.)

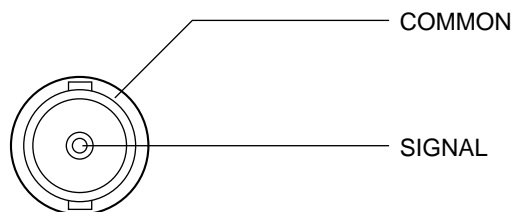

Note: If modification is made, the VOLT OUT connector can output current from 0 to 20 mA (corresponding to 0 to 20000 r/min). In this case, however, note that it cannot be used for voltage output..

⑳ BCD OUT connector

Used to output BCD data and status of RUN JUDGE/OVER RUN comparators with positive logic TTL level (with a fan out of 2). A printer is connected to this connector for data recording.

For the print commands, positive pulses with a pulse width of 1 ms and the TTL level (fan out of 2) are used. The applicable connector type is 57-30500 (Amphenol). The following shows the pin assignment.

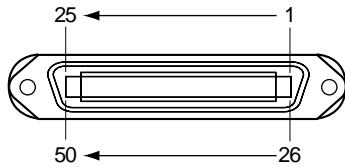

Pin No.	Signal	Pin No.	Signal	
1	1	26	↑ Not used ↓	
2	2	27		
3	4	28		
4	8	29		
5	1	30		
6	2	31		
7	4	32		
8	8	33		
9	1	34		
10	2	35		
11	4	36		
12	8	37		
13	1	38		
14	2	39		
15	4	40		
16	8	41		
17	1	42		
18	2	43		
19	RUN JUDGE	44		
20	OVER RUN	45		
21	Print command	46		
22	Not used	47		
23	0 V	48		0 V
24	0 V	49		0 V
25	0 V	50		0 V

㉑ PULSE OUTPUT SELECT switch

Used to switch the pulse type between 1P/R, DIRECT, and 60P/R, according to the purpose and usage of your application. The pulse selected by this switch is output from the pulse signal output connector ⑲.

- 1P/R : The pulse produced by multiplying the input signal is divided to obtain a 1P/R signal. The output pulse is not synchronized with the input signal. For example, for 6000 r/min display, 100 P/s pulse is output.
- DIRECT : The input signal is wave-shaped and output.
- 60P/R : The input signal is multiplied and output. For example, for 6000 r/min display, 6000 P/s pulse is output.

3. Measurement, Setting, and Adjustment Procedures

3.1 Measurement Procedure

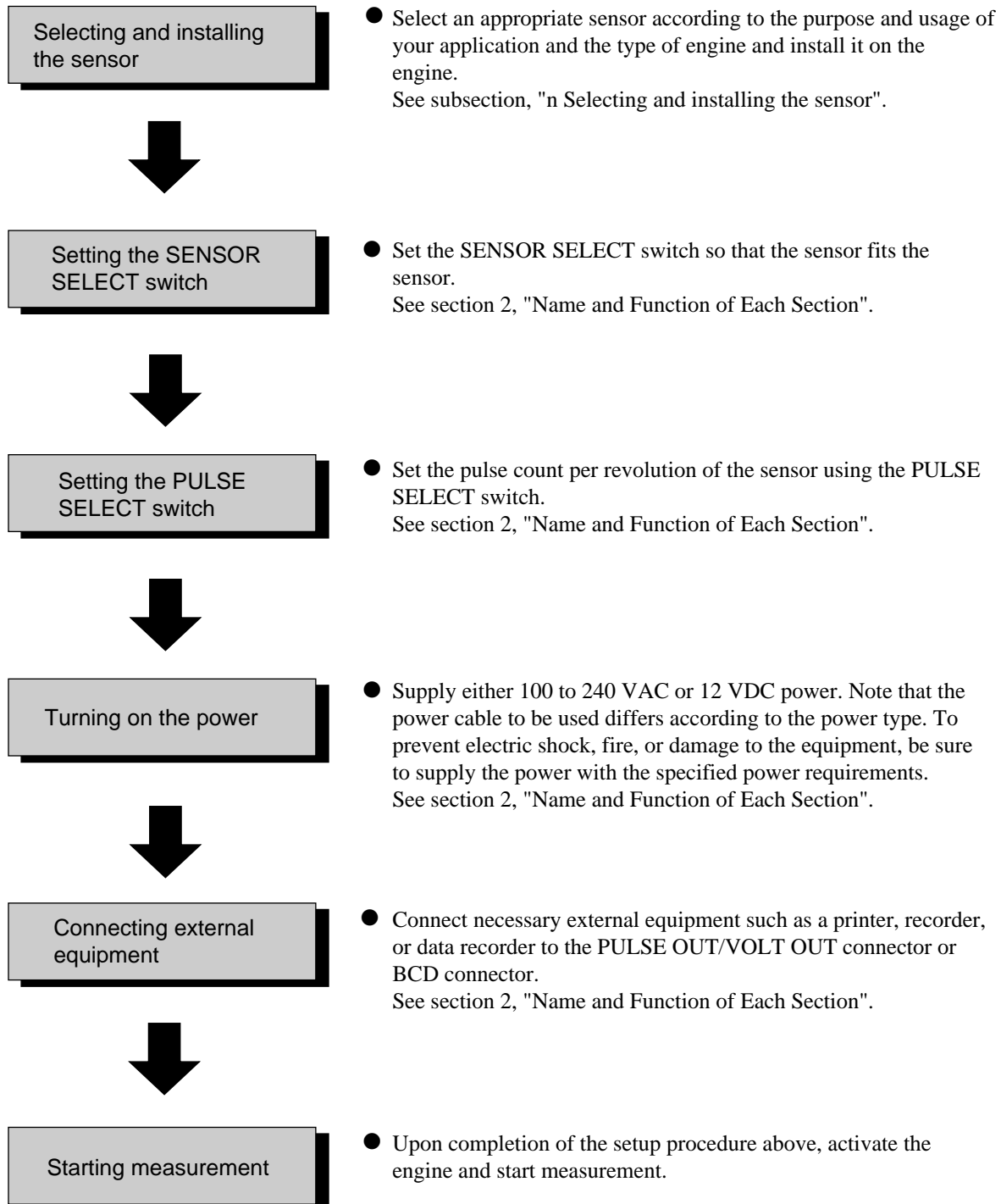

■ Selecting and Installing the Sensor

Referencing the figure and table below, install the selected sensor on the engine.

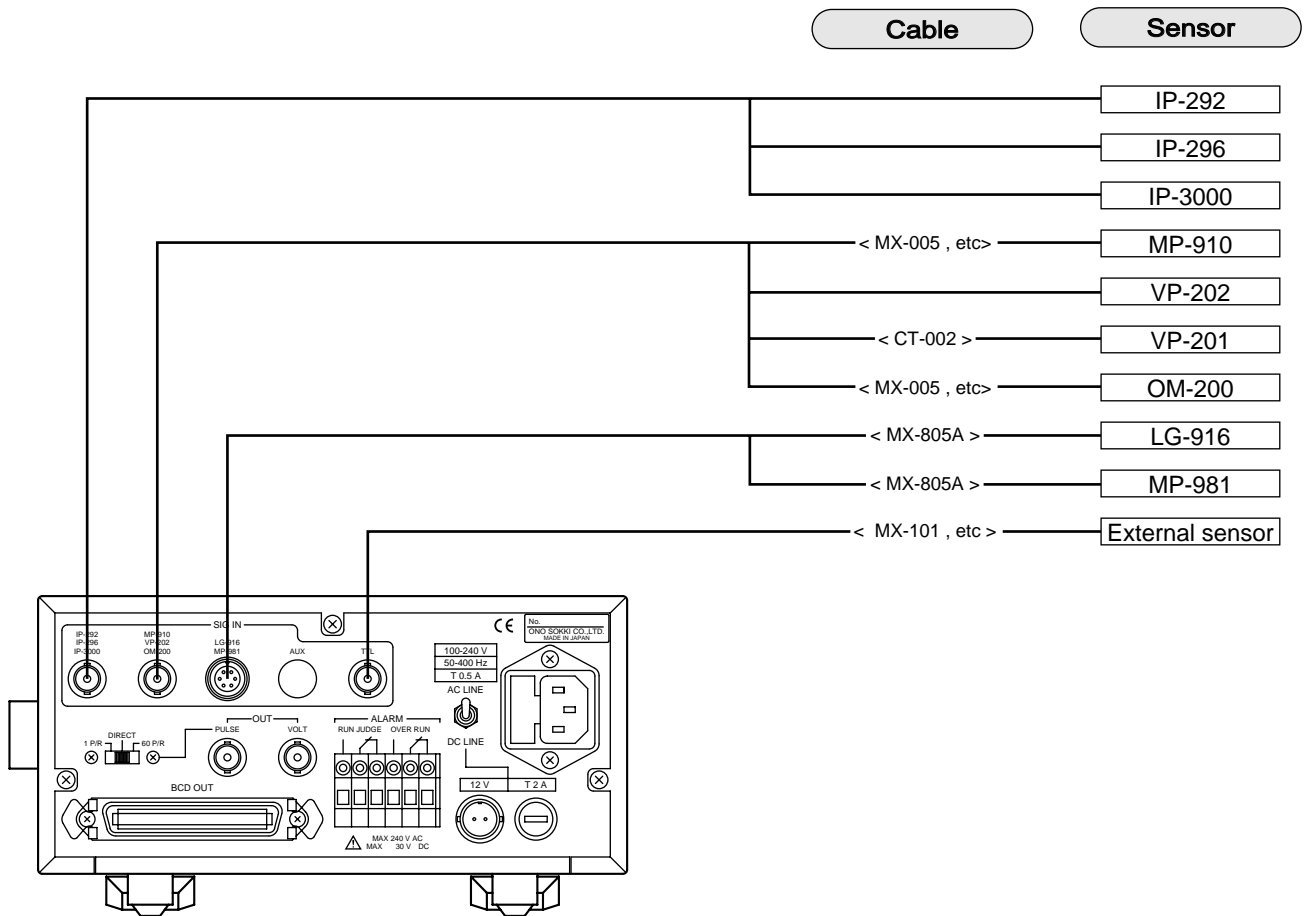

● **Sensor installation list**

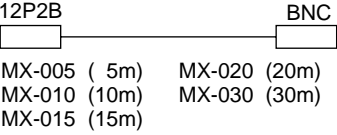
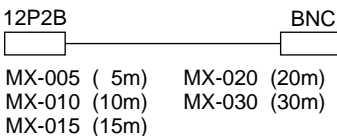
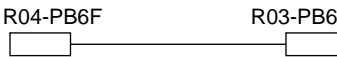
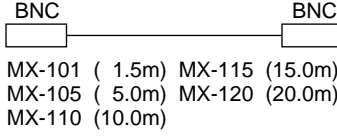
Sensor	Connection	Installation procedure
IP-292/296/3000 Ignition pulse sensor	Signal cable provided	Clip the cable of the ignition coil low-voltage primary side (IP-292) or the cable of the high-voltage secondary side (IP-296).
MP-910 Electromagnetic sensor	 <p>12P2B BNC</p> <p>MX-005 (5m) MX-020 (20m) MX-010 (10m) MX-030 (30m) MX-015 (15m)</p>	Attach a gear to the crankshaft (recommended type is MP-001). Secure the sensor with mount fittings.
VP-202 Engine sensor	Signal cable provided	Attach the magnet of the sensor to the cylinder head bolt or engine mounting bolt.
OM-200 Electromagnet sensor	 <p>12P2B BNC</p> <p>MX-005 (5m) MX-020 (20m) MX-010 (10m) MX-030 (30m) MX-015 (15m)</p>	Install the sensor in parallel with the ignition coil. Secure the sensor with mount fittings.
LG-916 Opto-fiber sensor	 <p>R04-PB6F R03-PB6M</p>	Attach the reflection mark onto the crankshaft. Secure the sensor with mount fittings.
MP-981 Electromagnetic sensor	<p>MX-805A (5m) MX-805 (5m) MX-810 (10m) MX-815 (15m) MX-820 (20m)</p>	Attach a gear to the crankshaft (recommended type is MP-001). Secure the sensor with mount fittings.
External sensor	 <p>BNC BNC</p> <p>MX-101 (1.5m) MX-115 (15.0m) MX-105 (5.0m) MX-120 (20.0m) MX-110 (10.0m)</p>	Depends on the sensor.

Notes: • For details on each sensor including handling precautions, specifications, and other notes, see each individual manuals.

3.2 Adjustment of the Input Trigger Level

If the input LED indicator on the front panel does not flash periodically, turn the input sensitivity adjustment knob to adjust the input trigger level. This section describes the adjustment procedure for the input signal for each sensor.

■ When the IP-292/296/3000 is connected

When the IP-292/296/3000 sensor is connected, follow the steps below to adjust the input trigger level.

Initially, make sure that there is no clearance at the clamp surface of the sensor. If any gap is present, eliminate it.

Then perform the following steps ① to ③ to adjust the trigger level.

The waveform of the ignition signal to be detected is as follows:

If the trigger level setting is not appropriate, e.g., if it is too low (as level A shown), some pulses cannot be detected; if it is too high (as level C shown), unnecessary noise is also detected.

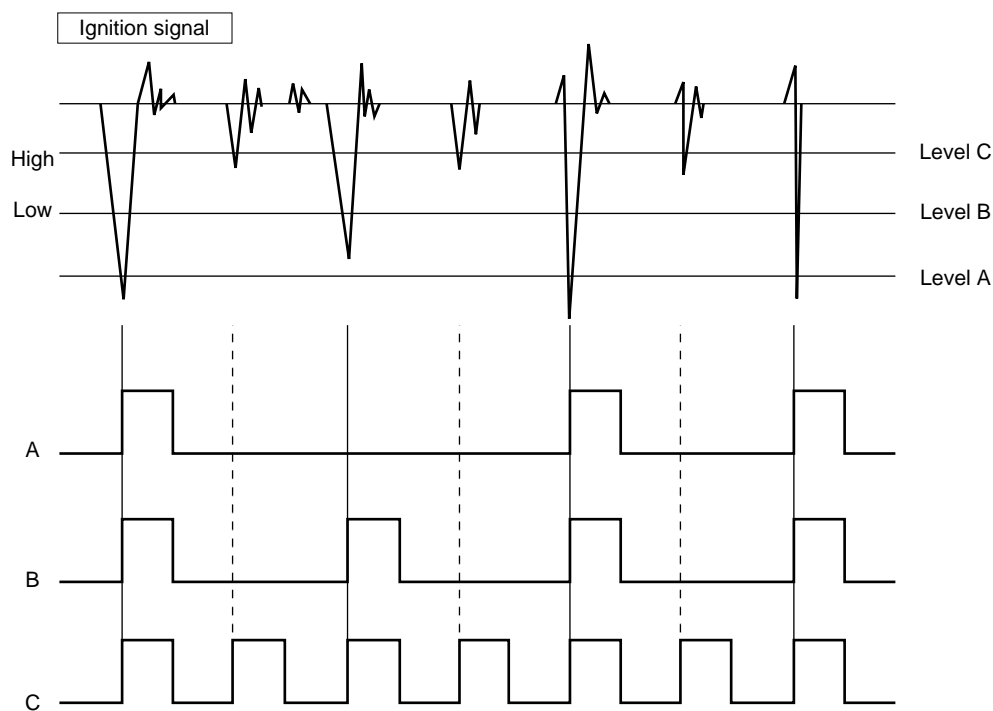

- ① During idling of the engine, increase the input sensitivity gradually from "5".
- ② Using the input sensitivity adjustment knob, set the input sensitivity to level B which is between level A (at which the input LED indicator starts flashing) and level C (at which the indicator goes on).
- ③ Increase the idling r/min of the engine to near the maximum value. In this case, make sure that a stable r/min display is obtained.

If the r/min display fluctuates at level A, increase the input sensitivity gradually to level B.

If the r/min display fluctuates even at level C, change the connecting position of the sensor.

If the r/min display fluctuates upon completion of the above adjustment procedure, it is assumed that the r/min value of the engine cannot be measured with the IP-292/296/3000. Use other type of sensors.

■ **When the VP-202/OM-200 is connected**

The input signal is affected by the VP-202/OM-200 depending on the mounting position.

If the input signal fluctuates after the trigger level adjustment procedure, change the mounting position of the sensor and then perform the procedure again.

If the input signal fluctuates after the trigger level adjustment procedure with various mount positions, it is assumed that the r/min value of the engine cannot be measured with the VP-202/OM-200. Use other type of sensors.

■ **When the LG-916/MP-981 is connected**

As the input trigger level for the LG-916/MP-981 is semifixed internally (i.e., level adjustment was made at the factory), it is not necessary to adjust the input trigger level.

There are cases when the input signal cannot be detected depending on the gap between the rotating body and the sensor. In such cases, see the instruction manual of the the LG-916/MP-981 and then install it again.

3.3 Checking the Display and Output Voltage

This subsection explains the check procedure for the digital display circuit and adjustment procedure for the analog output voltage.

- ① Set the SENSOR SELECT switch to "CHECK".
- ② Set the PULSE SELECT switch to a range from 0.5 to 8.0 and then check the digital display and the output voltage.

Make adjustment using the table below.

- ③ If the output voltage is not correct, adjust it using the OUTPUT ADJ trimmer.

ZERO : $\pm 4\%$ of the full scale

SPAN : $\pm 4\%$ of the full scale

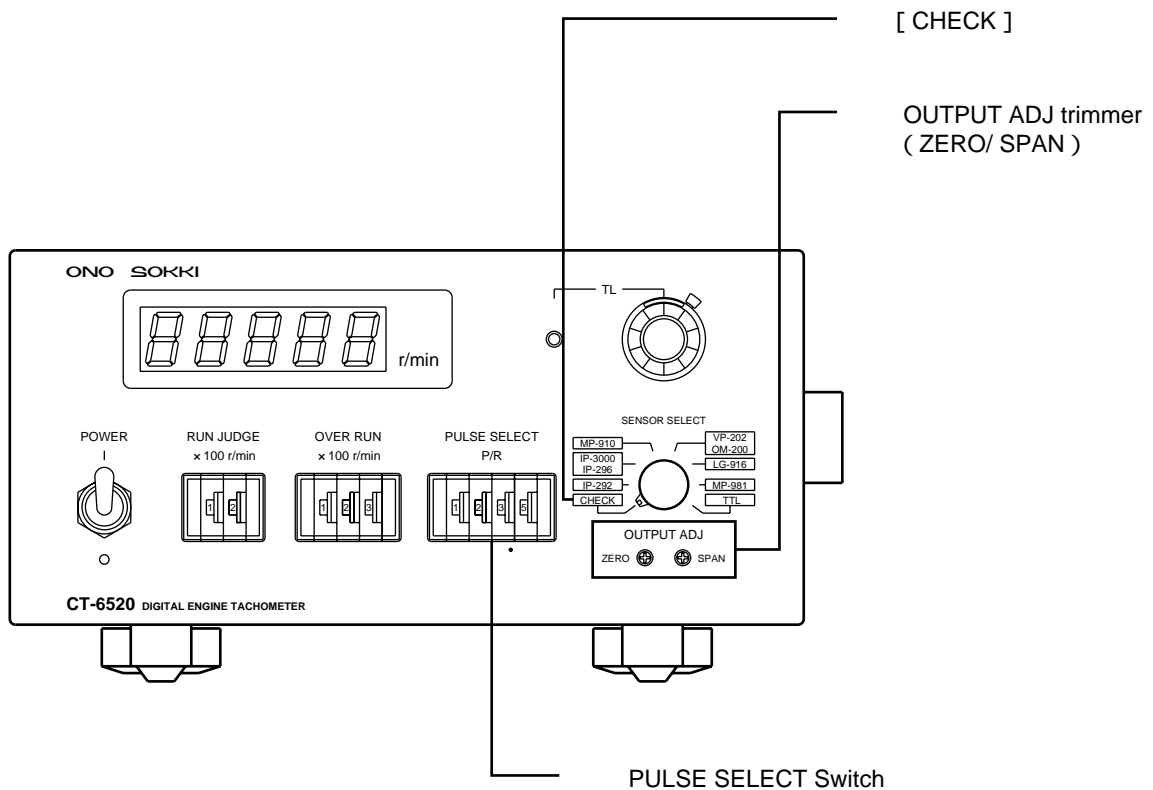

Input pulse count	Digital Display	Output voltage (V)
0.5	10000	5.000
1.0	5000	2.500
1.5	3333	1.666
2.0	2500	1.250
2.5	2000	1.000
3.0	1666	0.833
4.0	1250	0.625
8.0	625	0.312

4. Specifications

Input section

Applicable sensor (option)	IP-292/296/3000 OM-200 VP-201/202 MP-910/981 LG-916 TTL Fiber Sensor(Optional)
Measurement range	400 to 20000 r/min * The upper limit r/min depends on the sensor type and the setting of the PULSE SELECT switch.
Input pulse count	0.5 to 199.5 P/R (in 0.5 P/R steps) * The input pulse count depends on the sensor to be connected.
Trigger level	IP-292/296/3000, VP-202 and OM-200 : Adjusted by the adjustment knob Others: Semifixed internally

Digital display section

Display	Green LED (5 digits) (20000 r/min max.) 14 mm high character length	
Measurement range	Automatic repetition for each second	
Time reference	Reference oscillator	Crystal
	Oscillating frequency	16 MHz
	Precision	$\pm 100 \times 10^{-6}$
Display precision	400 to 20000 r/min ($\pm 0.02\%$ of the full scale, ± 1 digit or less)	

Analog output section

Output voltage	0 to 10 V/0 to 20000 r/min or 0 to 2 V/0 to 20000 r/min *2	
	Load resistance	1k Ω or more
	Linearity	$\pm 0.5\%$ of the full scale
	Output adjustment range	$\pm 4\%$ of the full scale (ZERO) $\pm 4\%$ of the full scale (SPAN)
	Response	Approx. 80 ms or less/10 to 90% *3
Output current (Option) *1	0 to 20 mA/0 to 20000 r/min	
	Load resistance	100 ohms or less
	Output adjustment range	$\pm 5\%$ of the full scale (ZERO) $\pm 10\%$ of the full scale (SPAN)
	Response	Approx. 80 ms or less/10 to 90% *3

*1 When modified to current output type, voltage output is disabled.

*2 Output of 0 to 2 V/0 to 20000 r/min is optional.

*3 When the input signal is absent, response is delayed by 3 to 4 seconds.

■ Digital output/pulse output/contact output section

Data output	BCD 5 digits (0 to 20000 r/min) Positive logic, TTL level, fan out of 2 With print command, RUN JUDGE and OVER RUN output
Output pulse count	1P/R 60 P/R (asynchronous to the input signal) / wave-shaped output of the input signal TTL level, fan out of 2
Contact output	RUN JUDGE : 1 to 99 × 100 r/min OVER RUN : 1 to 199 × 100 r/min Comparison interval : 100ms Transfer contact Contact capacity : 240 VAC/2A, 30VDC/2A

■ General data

Power supply	AC power	100 VAC ±10%, Approx. 25 VA
	DC power	11 to 15 V, Approx. 13 V
Operating temperature range	0 to +40 °C	
Dimension	210 (W) × 99 (H) × 300 (D) mm	
Weight	Approx. 3 kg	
Accessory	AC power cable	× 1 (1.9 m)
	DC power cable	× 1 (3.5 m)
	Conversion adapter	× 1 (CM-33)
	AC power fuse	× 1 (0.5A midget fuse)
	DC power fuse	× 1 (2.0A midget fuse)
	Instruction manual	× 1

5. Applicable Sensors List

For gasoline engines	IP-292/296 /3000	Detects spark signal from the ignition system via the ignition coil cable. Used at the ignition coil low-voltage primary side (IP-292) or the cable of the high-voltage secondary side (IP-296).
	OM-200	Detects leakage magnetic flux from the magnet engine shaft with the magnet ignition system. Installed in parallel with and approx. 30 mm apart from the ignition coil. Set the input pulse count according to the number of magnets.
For gasoline and diesel engines	VP-201/202	Detects vibration due to vertical motion of the piston, based on the galvanic electricity vibration detection method. With the magnet on the bottom, attached to the cylinder head bolt or engine mounting bolt. (Cannot be used for engines with 6 or more cylinders.)
For gasoline and diesel engines and other rotating bodies	MP-910	Electromagnetic induction sensor incorporating permanent magnet and sensor coil Located in proximity of the tip of the detection gear mounted on the shaft. Picks out frequency signal which is proportional to the r/min value. Can be used for other sensors of the MP-910 series such as the MP-930 (oil-proof type).
	MP-981	Incorporates a magnetic resistor, a permanent magnet, a dc amplifier, and a voltage regulator, realizing the magnetic flux response type. Detects a wide range of rpm in the form of square wave with the same amplitude. Located in proximity of the tip of the detection gear mounted on the shaft. Picks out frequency signal which is proportional to the r/min value.
	LG-916	Reflective type sensor using an opto-fiber at the top With the unit incorporating a photo emitter, photo receptor, and amplifier, detects the r/min value by means of photo emission and reception. Allows non-contact detection with the reflection mark attached on the shaft.

6. Outside Dimensions

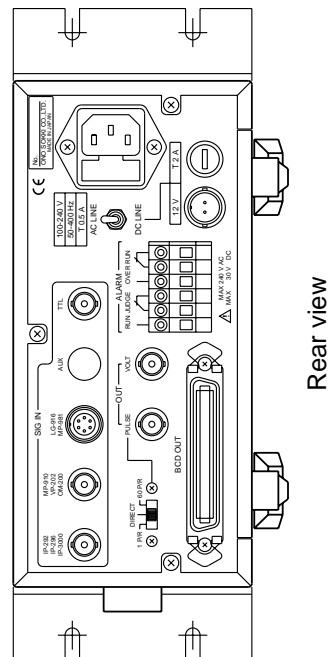
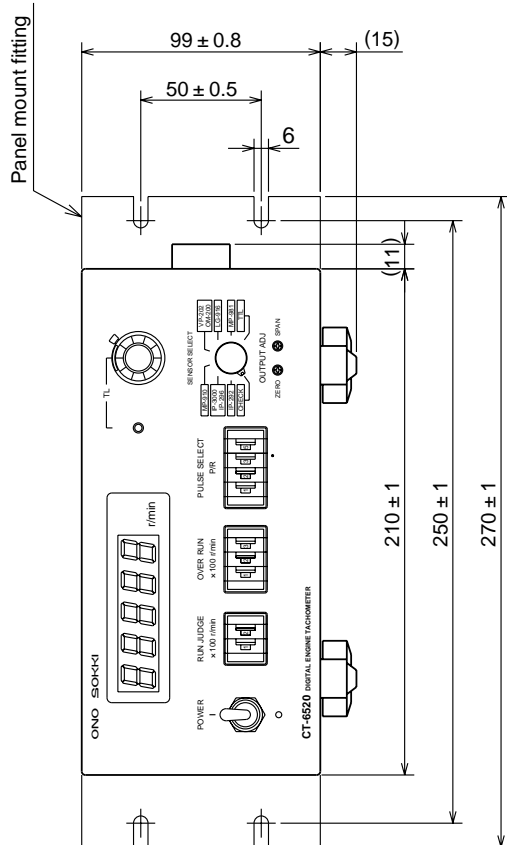
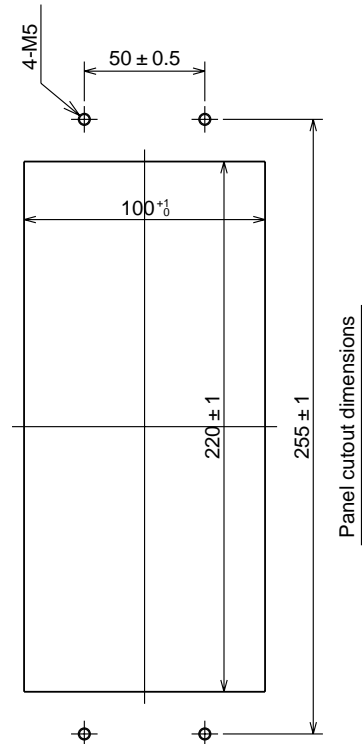
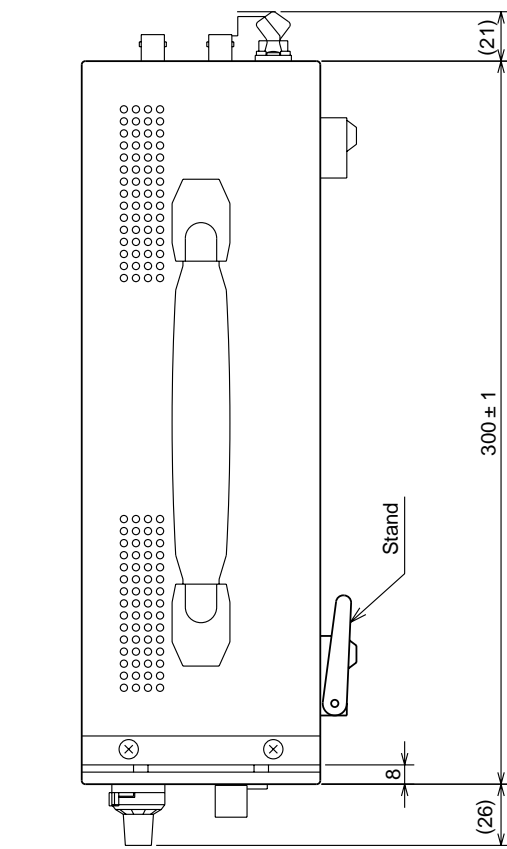

ONO SOKKI

ONO SOKKI

*Outer appearance and specifications are subject to change without prior notice.

HOME PAGE: <http://www.onosokki.co.jp/English/english.htm>

WORLDWIDE

Ono Sokki Co., Ltd.

1-16-1 Hakusan, Midori-ku,

Yokohama 226-8507, Japan

Phone : 045-935-3976

Fax : 045-930-1906

E-mail : overseas@onosokki.co.jp

B00001671/IM00020101(3) 029(MS)010