

Thank you for your selection of the HT-3200 Handheld Digital Tachometer.

To ensure the performance of the HT-3200, please read this manual thoroughly.

Warnings and Cautions

In this document precautions are classified into two categories: **WARNING** and **CAUTION**. This depends on the degree of danger or damage possible if the precaution is ignored and the product is used incorrectly.

WARNING This symbol is used to indicate precautions where there is a risk of death or serious personal injury to the operator if the product is handled incorrectly.

CAUTION This symbol is used to indicate precautions where there is a risk of some personal injury to the operator or only material damage to the product if the product is handled incorrectly.

Copyright © ONO SOKKI CO., LTD. 2012 All rights reserved.

Omission of Issuance of Certificate

This product has been tested under strict inspections for correct operation before shipment. Please note that the issuance of certificate is omitted.

Warranty

1. This product is covered by a warranty for a period of one year from the date of delivery.
2. This warranty covers free-of-charge repair during the warranty period for defects occurred while the product is used under correct operating conditions according to descriptions in this manual and notices on the unit label.
3. For free-of-charge repair during the warranty period, contact your dealer or your nearest Ono Sokki sales office nearby.
4. Even during the warranty period, the following failures will be handled on a fee basis.
 - (a) Failures or damages occurring through misuse, misoperation, repairing without ONO SOKKI'S approval.
 - (b) Failures or damages occurring through mishandling (dropping) during transportation after purchase.
 - (c) Failures or damages occurring by an Act of God (fires, earthquakes, flooding, and lightning), environmental disruption, or abnormal voltage.
 - (d) Replenishment of expendable supplies, spare parts, and accessories.

This guarantee covers only the performance of the product itself only.

All inconvenience by the trouble of this product is not included.

*Outer appearance and specifications are subject to change without prior notice.

HOME PAGE: <http://www.onosokki.co.jp/English/english.htm>

WORLDWIDE

ONOSOKKI CO., LTD.
1-16-1 Hakusan, Midori-ku,
Yokohama 226-8507, Japan
Phone : +81-45-935-3918
Fax : +81-45-930-1808
E-mail : overseas@onosokki.co.jp

Observe the Following Points before Use

General Precautions

- **Be sure to read this instruction manual.**
To take advantage of the excellent performance of this product and use it safely, be sure to thoroughly read this instruction manual.
- **Avoid rapid temperature change.**
Do not move the product rapidly from a hot place to a cold one or vice versa. Condensation can form inside the unit which may cause failure.
- **Be careful not to get water, dust, or foreign materials inside the unit.**
Do not use the product in places where you may get water or oil or places which are humid or dusty.
- **Do not drop the product or apply excessive shock to it.**
Since this product incorporates high-precision electronic parts, be careful not to drop it or apply strong shock.
- **Wipe dirt off using a dry cloth or a cloth dampened with neutral detergent and squeezed firmly.**
Do not use volatile oils (thinner or benzene) or alcohols.
- **If you do not use the product for a prolonged period of time, be sure to remove the batteries.**
Leaving it unused for a prolonged period of time or exhausted batteries may cause battery leakage.

Use the HT-3200 safely observing the above precautions. To make assurance double sure, we recommend to wear protection glasses during measurement.

Overview

1. Overview

This product is a contact type handheld tachometer with built-in batteries integrating the rotary detector, measurement unit, and display. It can measure rotational speed simply by pressing the contact tip into the center hole at the end of a rotating shaft under measurement. It can also be used for measurement of circumferential speed by replacing the contact with the circumferential ring.

2. Features

- Compact light-weight body and large LCD.
- Can measure from 5 r/min to 10,000 r/min in steps of 1 r/min (Hi range).
- Can measure from 0.5 r/min to 2,000.0 r/min in steps of 0.1 r/min by selecting the Lo range.
- Memory function (with up to 10 memory numbers) which is useful for checking measurement results
- Over-range display function which fixes the display value to the maximum value and displays the "ERROR" mark if a measurement value exceeds each measurement range.
- Retains the display of the final measurement value for about 30 seconds after completion of measurement.
- Accessories can be stored in the main unit.

Option

- ① KS-100 : Circumferential ring (mm/s)
- ② KS-700 : Extention shaft
(Do not use the extention shaft for the circumferential ring.)
- ③ HT-0300 : Carrying case

WARNING

- The maximum rotational speed which can be measured by the HT-3200 is 10,000 r/min. Do not use the HT-3200 for measurement of objects rotating at 10,000 r/min or higher.
- Be sure to check the contact tip and circumferential ring before use. Do not use contact tips or circumferential rings with worn rubber, cracked resin, or loose mounting condition. Replace such parts with new genuine parts from Ono Sokki.
- If the rotational speed exceeds a measurement range of each range, "ERROR" appears. When the HT-3200 is used with the "Lo" range, select the "Hi" range. If "ERROR" appears during operation with the "Hi" range, stop measurement.
- Never perform measurement of rotational speed using the circumferential ring because it is dangerous. Be sure to use the contact tip for measurement of rotational speed. If there is no center hole on the shaft under measurement, use a non-contact tachometer, such as the HT-4200.
- When inserting the contact and circumferential ring, align the slit-like notch with the pin position of the detection shaft and then securely insert the detection ring into it until it fits into place.
- or measurement of rotational speed, press the contact tip correctly to the shaft under measurement so that the center of the shaft under measurement agrees with the shaft center of the contact tip while securely holding the HT-3200.

3. Unpacking

When you unpack the unit, make sure that you have all the following:

- ① HT-3200 main unitx1
- ② Contact tip (KS-300 stored in battery compartment)x2
- ③ Circumferential ring (KS-200 stored in battery compartment)x1
- ④ Type AAA dry batteryx3
- ⑤ Instruction manualx1

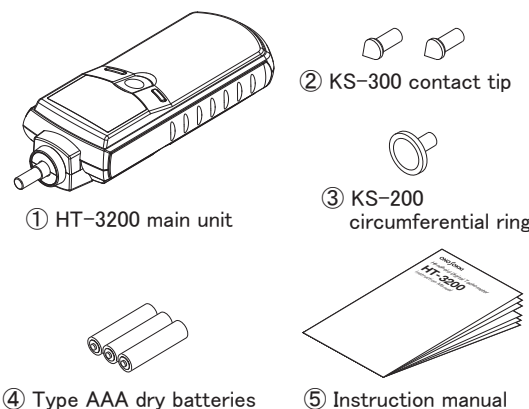

Note: Since the supplied batteries are samples, some may be exhausted quickly.

Storage

The storage temperature range of the HT-3200 is -10 °C to +55 °C. When you store it, avoid locations where the temperature is extremely high or low or the humidity is high. Store it in a place which is well-ventilated and not exposed to direct sunlight. If you do not use it for a prolonged period of time, be sure to remove the batteries to prevent accident caused by battery leakage, etc.

Name and Function of Each Section

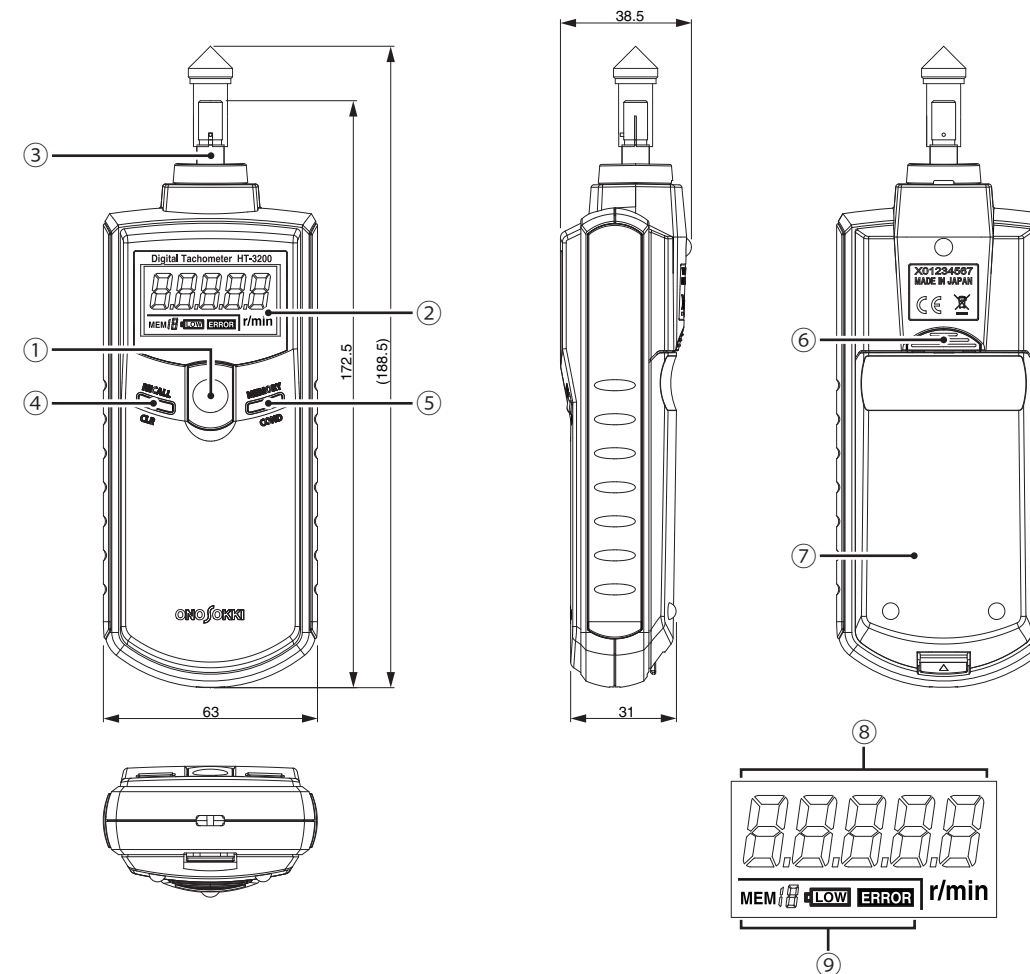

① Power switch

Turns the power ON or OFF. Even if you release the power switch, the power ON condition is retained for 30 seconds (measurement is not possible).

② Display

Displays measurement values and various conditions.

③ Detection shaft (In Fig. above, the contact is attached.)

Attach the contact tip, circumferential ring, etc. to this shaft.

④ RECALL/CLR switch

Recalls memorized measurement values and clears them at one time.

⑤ MEMORY/COND switch

Writes data in memory at the time of measurement, selects

the setup mode, and changes settings.

⑥ Finger stopper

In measurement in an environment with much static electricity, this finger stopper releases static electricity to protect the main unit.

⑦ Battery cover

Remove this cover to replace the batteries. Use three Type AAA dry batteries. This compartment is also used to store the contact tip and circumferential ring.

⑧ MAIN display

Displays measurement values and settings.

⑨ SUB display

Indicates the memory address (memory number), LOW battery, and error.

Power Supply

The HT-3200 operates on three Type AAA batteries. If the batteries are exhausted and the LOW mark "LOW" appears, replace them with new ones. Be sure to replace all the three batteries at the same time.



Battery replacement procedure

- ① While pushing lightly the △ mark at the rear end of the battery cover with your finger, raise it to remove.
- ② Put batteries properly in the battery compartment with the correct polarity (+/-).
- ③ Close the battery cover.

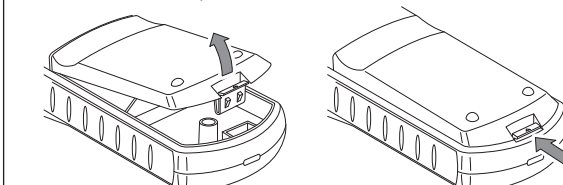

Operations

1. Measurement

■ Measurement of Rotational Speed

- Attach the contact tip (KS-300) to the detection shaft. At this time, align the slit-like notch of the contact with the pin position of the detection shaft and then securely insert the detection ring into it until it fits into place.
- Select a measurement range. When you press and hold the MEMORY/COND switch for at least 2 seconds, the measurement range setup mode is entered and the current measurement range appears in the MAIN display. Each time you press the MEMORY/ COND switch, the measurement range switches between "Hi" and "Lo." Select a target range.

| Measurement Range | Measurable Range |
|-------------------|----------------------|
| Lo | 0.5 to 2,000.0 r/min |
| Hi | 5 to 10,000 r/min |

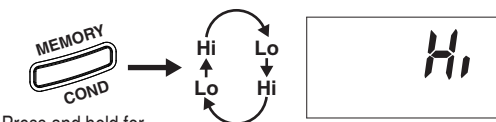

Press and hold for at least 2 seconds

- Press the power switch to return to the measurement mode. The current display value is applied. If you perform no operation for 30 seconds in the setup mode, the display value immediately before turning OFF the power is applied.
- Press and hold the power switch, and press the contact into the center hole at the end of the rotating shaft under measurement so that it does not slip. At this time, hold the HT-3200 so that the center of the rotating shaft under measurement agrees with that of the detection shaft.
 - Do not use solids of rotation without a center concave (center hole).
 - Measurement error may arise depending on the material of the solid of rotation and the fitting condition of the contact.

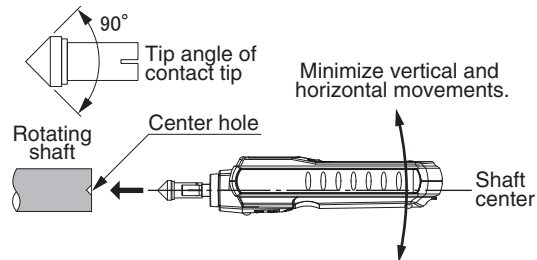

- While you hold the power switch, the rotational speed is displayed in digital form at 1-second intervals.
- When you release the power switch, the display of the last measurement value is retained for about 30 seconds and then automatically turns off.

■ Measurement of Circumferential Speed

- Attach the circumferential ring (KS-100 in mm/s (option) or KS-200 in m/min (accessory)) to the detection shaft. At this time, align the slit-like notch of the circumferential ring with the pin position of the detection shaft and then securely insert the detection ring into it until it fits into place.
- Set a measurement range. (Refer to "Measurement of Rotational Speed" for setup operations.)

| Type Range | KS-100 (option) | KS-200 (accessory) |
|------------|---------------------|----------------------|
| Lo range | 0.5 to 2,000.0 mm/s | 0.05 to 200.00 m/min |
| Hi range | 5 to 10,000 mm/s | 0.5 to 1,000.0 m/min |

- Press and hold the power switch, and press the circumferential ring onto the object under measurement. At this time, correctly press it so that the flow direction of the object under measurement be in parallel with the rotational direction of the circumferential ring, while securely holding the HT-3200.

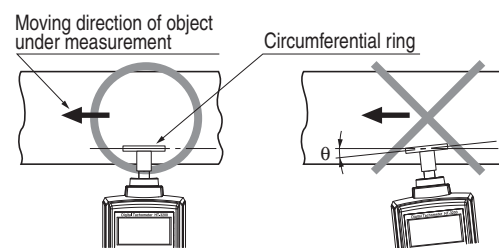

- While you hold the power switch, the circumferential speed is displayed in digital form at 1-second intervals.

【Conversion of display value】

In measurement of circumferential speed, you need to convert the display value because it cannot directly be read. In the case of the KS-200 (accessory) with a circumference of 10 cm, a display value of 500 r/min is converted to 50.0 m/min. In the case of the KS-100 (option) with a circumference of 6 cm, a display value of 500 r/min is converted to 500 mm/s.

2. Notes on Measurement

- The maximum rotational speed which can be measured by the HT-3200 is 10,000 r/min. Do not use the HT-3200 for measurement of objects rotating at 10,000 r/min or higher.
- Be sure to check the contact tip and circumferential ring before use. Do not use contact tips or circumferential rings with worn rubber, cracked resin, or loose mounting condition. Replace such parts with new genuine parts from Ono Sokki.
- Never perform measurement of rotational speed using the circumferential ring because it is dangerous. Be sure to use the contact tip for measurement of rotational speed. If there is no center hole on the shaft under measurement, use a non-contact tachometer, such as the HT-4200.
- Using the product in atmosphere with much static electricity may cause malfunction. To avoid accumulation of static electricity inside the instrument, touch the finger stopper by a finger as shown below to release static electricity.

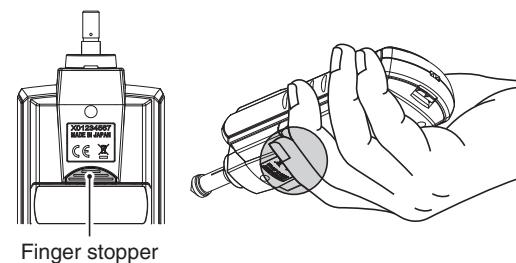

3. Measurement Value Memory Function

(1) Memorizing measurement values

- To memorize the current measurement value, press the MEMORY/COND switch in the measurement mode.
- When a measurement value has been memorized, the memory number in the SUB display is incremented.
- Up to 10 measurement values can be memorized. If you press the MEMORY/COND switch after memorizing 10 values, "FULL" is displayed in the MAIN display for about one second indicating that no more values cannot be memorized.

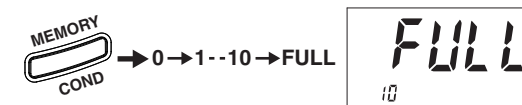

(2) Recalling measurement values

- Memorized values can be recalled by pressing the RECALL/CLR switch in the measurement mode. The SUB display displays the memory number like "MEM XX" (example: MEM 5).
- The value memorized last is recalled first, then, in order of the memory number: MEM 1, MEM 2, MEM 3, ... MEM 10.
- When three values have been memorized, for example, the value memorized in MEM 3 is displayed first and the SUB display indicates MEM 4. The MAIN display displays "-----" indicating that there is no more memorized values. Therefore, if there is no memorized value in memory, "-----" is displayed for MEM 1.

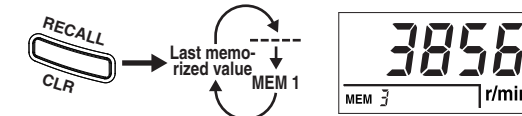

- To return to the measurement mode from the RECALL mode, press the power switch or leave the HT-3200 without making any switch operation for 30 seconds to turn OFF the power.

(3) Clearing (all) memorized values

- To clear the memory contents, press the RECALL/CLR switch for at least 2 seconds. When the memory has been cleared, "CLR" is displayed in the MAIN display for about one second.

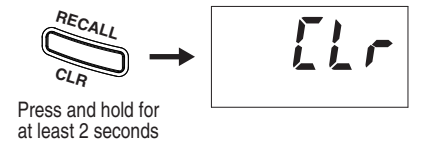

4. SUB Display

■ ERROR Display

If the rotational speed exceeds each measurement range, the MAIN display is fixed to the maximum value and the "ERROR" mark appears in the SUB display. When the HT-3200 is used with the "Lo" range, select the "Hi" range. If the "ERROR" mark appears during operation with the "Hi" range, stop measurement. The maximum rotational speed which can measure by the HT-3200 is 10,000 r/min.

■ LOW Battery Display

If the LOW mark "LOW" lights up, it indicates that the dry batteries have been exhausted.

- This mark lights up if the battery voltage drops to 3.3 V or lower.
- If the mark lights up, immediately replace the three dry batteries with new ones. Using the exhausted batteries may disable measurement.

Specifications

1. Measurement Section

Operation method : 0.1 r/min (Lo range)
1 r/min (Hi range)

Measurement range : 0.5 to 2,000.0 r/min (Lo range)
5 to 10,000 r/min (Hi range)
0.05 to 1,000.0 m/min (with KS-200) (*1)
0.5 to 10,000 mm/s (with KS-100) (*1)

(*1) When the circumferential ring is used, conversion of numerical value and unit is required.

Measurement accuracy :

Lo range ; 0.5 to 1,249.9 r/min \pm 0.1 r/min
1,250.0 to 2,000.0 r/min \pm 0.2 r/min

Hi range ; 5 to 10,000 r/min \pm 1 r/min

Over-range display : If a measurement value exceeds each measurement range, the MAIN display value is fixed to the maximum value and the "ERROR" mark appears in the SUB display.

2. Rotary Detector

Number of pulses : 60 P/R

Detecting element : Transmissive photo-sensor

3. Display

Number of display digits : 5 digits

Character height : 10.5 mm

Indicator : 7-segment LCD

Refresh time : 1 second (Lo range: 2 seconds for 0.5 to 1.0 r/min)
1 second (Hi range: 2 seconds for 5 to 10 r/min)

4. Measurement Mode

Data hold function : When measurement is completed, the display of the last measurement value is retained for about 30 seconds and then automatically turns off (auto power off).

Memory function : A measurement value is stored in memory each time the MEMORY/COND switch is pressed. Up to 10 measurement values can be memorized. Since these values are stored in non-volatile memory, they are retained even after you turn OFF the power.

5. General Specifications

Power supply : Type AAA dry battery (x3)

Continuous operating time : About 20 hours (with alkali dry batteries at 20 °C)

Battery LOW display : When the battery voltage drops to 3.3 V or lower, the LOW mark "LOW" lights up.

Operating temperature range : 0 °C to +40 °C

Storage temperature range : -10 °C to +55 °C

Operating humidity range : 35 to 85%RH (without condensation)

Storage humidity range : 35 to 85%RH (without condensation)

Mass : About 160 g (dry batteries not included)

Dimensions : 172.5 x 63 x 38.5 mm

6. Applicable Standards

- CE Marking
- EMC Directive (2004/108/EC)

Troubleshooting

If you perceive any abnormal condition, first check the following points. If the instrument does not operate normally after check, contact your dealer (Ono Sokki agency) or Ono Sokki sales office nearby.

| Symptom | Check Point | Check Point |
|--|--|---|
| ● No display | <ol style="list-style-type: none"> Are batteries set ? Is the battery polarity correct ? Are batteries exhausted ? Does the display recover after replacing the batteries ? | <ol style="list-style-type: none"> Set batteries. Change the battery polarity correctly. Replace all batteries with new ones. Perform the reset operation. <ol style="list-style-type: none"> Remove the batteries. Press and hold the power switch for several seconds. Set the batteries. |
| ● The display value differs from the actual value. | <ol style="list-style-type: none"> Is the tip of the contact tip worn out and deformed ? Are the solid of rotation and contact tip slipping ? Is the LOW mark "LOW" lit ? Are you holding the power switch ? | <ol style="list-style-type: none"> Replace the contact tip with a new one. Hold the main unit firmly to avoid slip. Replace all the batteries with new ones. Press and hold the power switch. |